

It is  
Big  
Bold  
Stylish  
Versatile

**800x  
2400mm**

**15mm Thickness**

# It is

## Big

800x2400mm

## Bold

15mm Thickness

## Stylish

Matt, Carving Matt & Glossy Finishes

## Versatile

Multiple Applications

### Sintered Stone by Motto

The Sintered Stone by Motto is a modern ceramic marvel made from natural materials whilst eliminating the limitation of natural stones like porosity, low heat, and stain resistance, and offering an eco-conscious, functional, and aesthetic tiling solution.

**ERIC**<sup>®</sup>  
REDEFINED BEAUTY



SINTERED **STONE**



# What is Sintered Stone?

Sintered Stone by Motto is an exceptional range of ceramic products complexly fabricated using sintering technology. The technology produces durable and resilient ceramic tiles & slabs using natural raw materials and compacting them under extreme pressure and heat transforming materials much stronger than their individual parts.

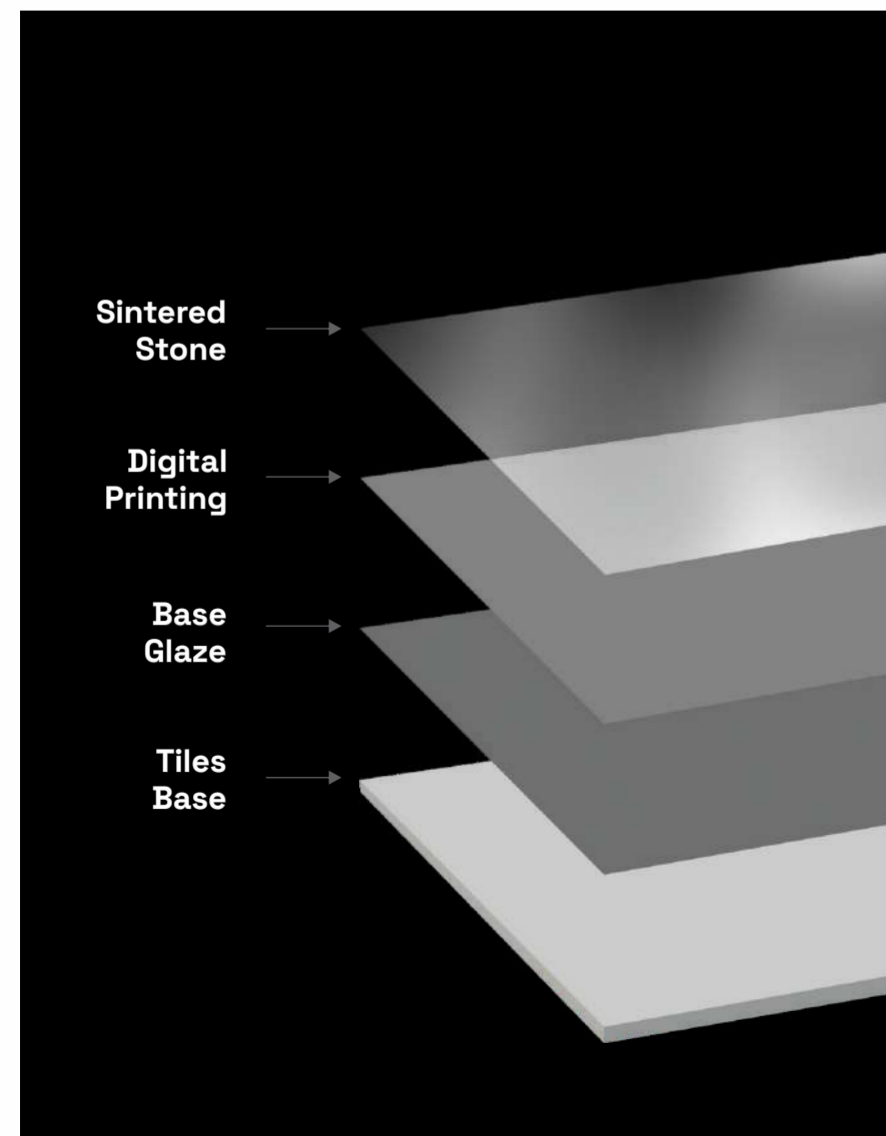









Motto employs the latest Continua+ from Sacmi - the most advanced technology in the ceramic industry enabling a single plant to manufacture a wide range of tile sizes, thicknesses, and decorations with zero wastage 100% recyclability, low cost of operation, and the lowest energy consumption.

The technology is equipped with computer vision optimizing surface decoration facilitating sharper on-tile detailing. The technology also integrates automated powder decoration and native connection to H.E.R.E for enhanced Digital Manufacturing 4.0 processes.



## Benefits of Sintered Stone by the House of Motto

The durable build, resilient form, and superior quality of the Sintered Stone offer extensive benefits making it ideal for modern-day lifestyles and spaces with features that offer effortless maintenance.

-  **Durable Material**
-  **Weatherproof**
-  **Heat & Fire Safe**
-  **Water Resistant**
-  **Stain Resistant**
-  **Chip & Scratch Resistant**
-  **Easy to Clean**
-  **Food Safe & Hygienic**



# Application Areas of Sintered Stone

Available in a versatile range of designs and colors, robust thickness, colossal format, and unmatched features, the Sintered Stone is ideal for multifarious and extensive applications indoors and outdoors including wall and furniture cladding, staircase, swimming pool borders, and a lot more.

- Flooring
- Stairs
- Exterior Wall Cladding
- Swimming Pool Border
- Dining Table Top
- Commercial Areas
- Kitchen Counter Top
- Metros & Railway Stations
- Bathroom Vanities
- Patios and Outdoor Flooring



**ERIC**<sup>®</sup>  
REDEFINED BEAUTY

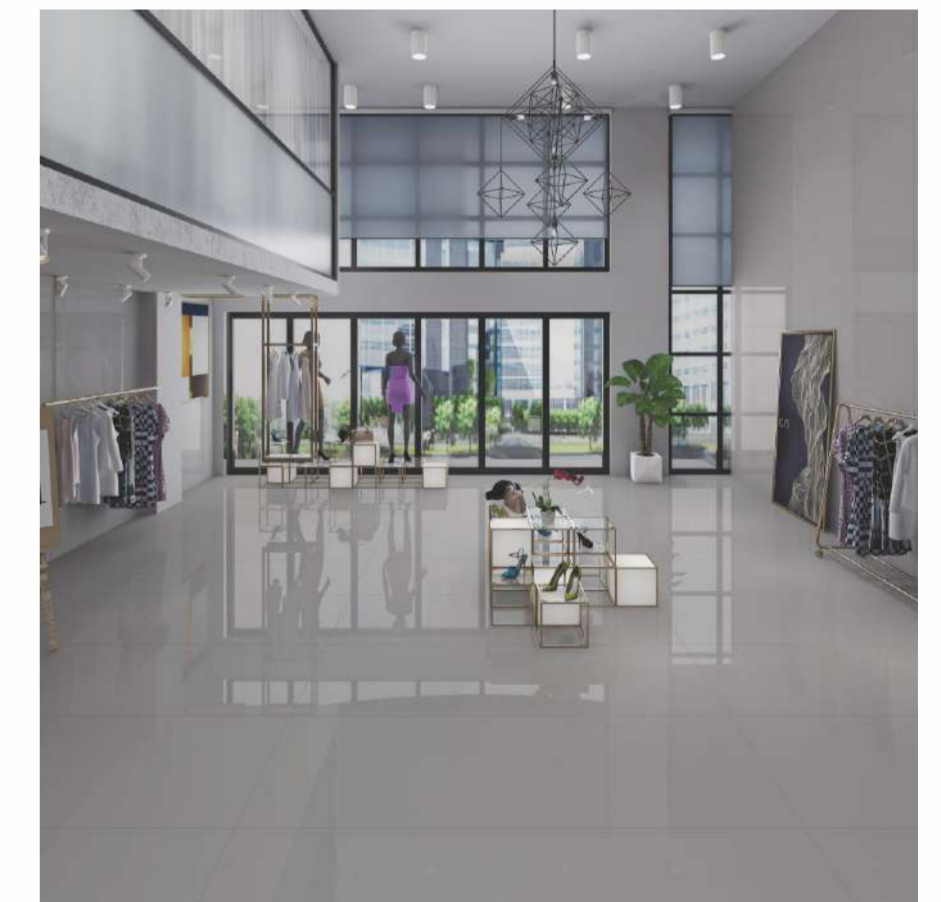



# Versatile format & thickness of Sintered Stone

The collection is available in the magnificent size of 800x2400mm and 15mm durable thickness making it ideal for a plethora of seamless applications without unflattering grout lines promoting flawless look and enhanced hygiene.

800x2400mm  
80x240cm



# Superior surfaces of the Sintered Stone



Diligently designed and meticulously processed, the collection offers multiple surface and body options opening new frontiers of design excellence in spaces.

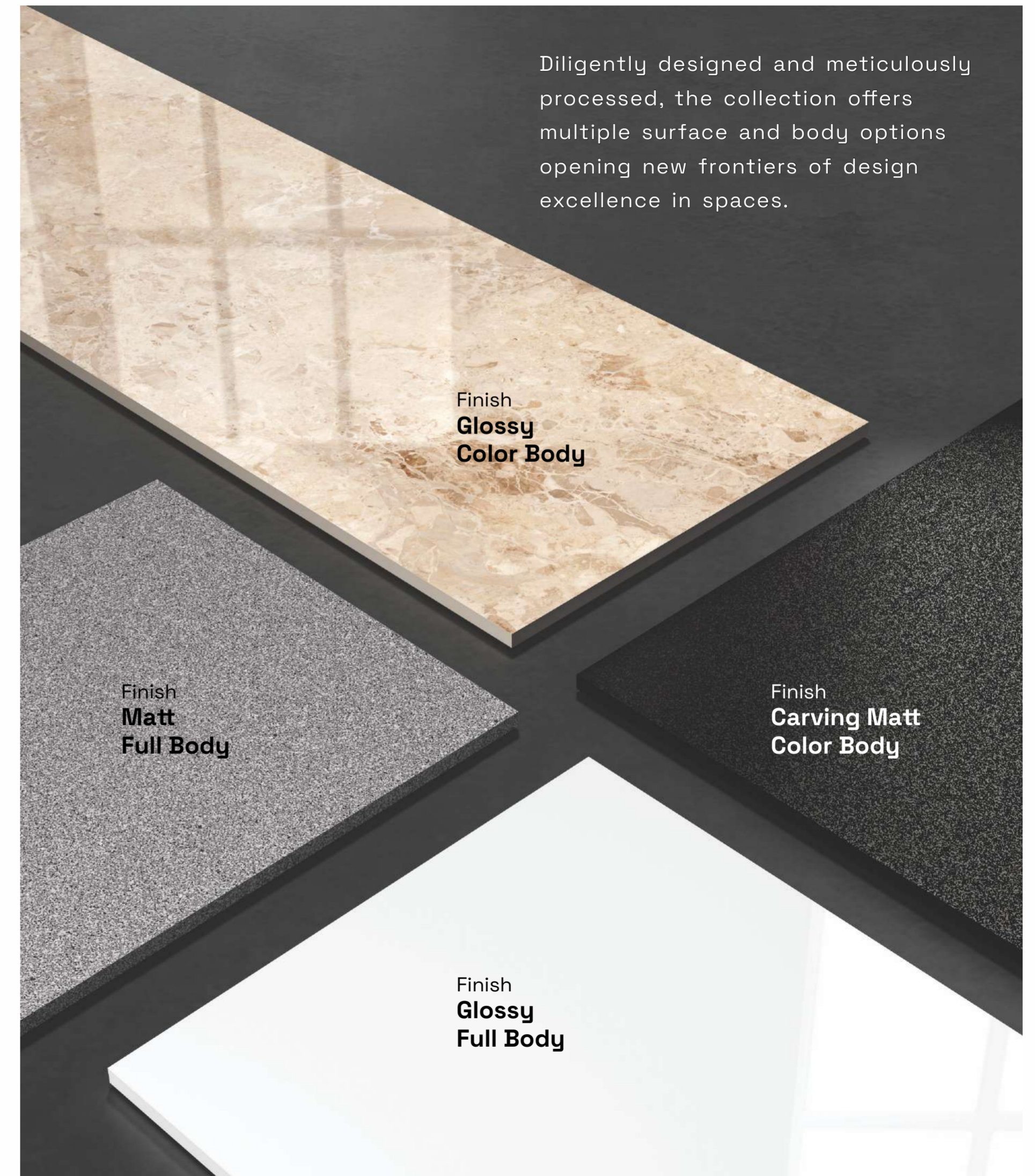



# An aesthetic array of designs & colors

Available across three versatile collections - Salt & Pepper, Plain, and Marble, The Sintered Stones is a feat of multifaceted, adaptable, and trend-transcending ceramic aesthetics breaking boundaries of innovation and style.

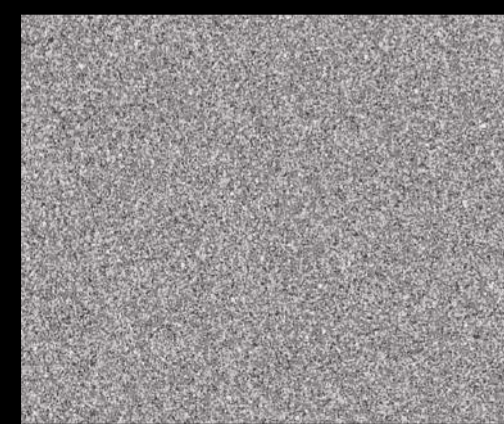

**SNP Collection**

Page 14 | 33



**Plain Collection**

Page 34 | 57



**Marble Collection**

Page 58 | 111

## SNP Collection



Royal Quartz



Galaxy White



Roma White



Galaxy Ivory



SNP Brown

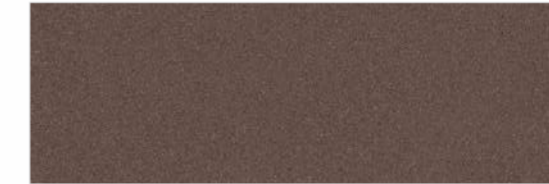

SNP Beige



SNP Verde

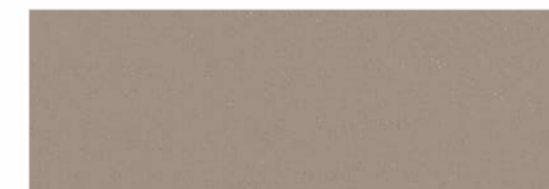

SNP Grey



SNP Black



## Plain Collection

Nano White

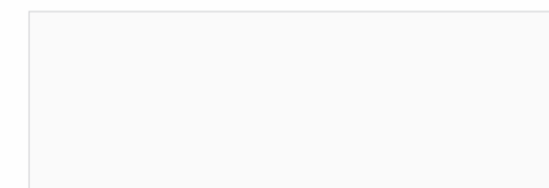

Nano Black



Light Grey

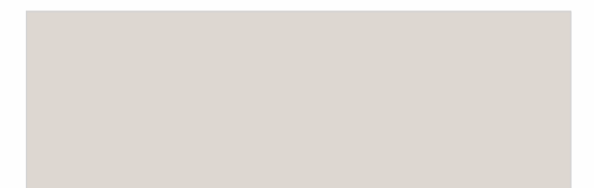

Steel Grey



Dark Grey



Fossil Grey



Kotta



Ivory

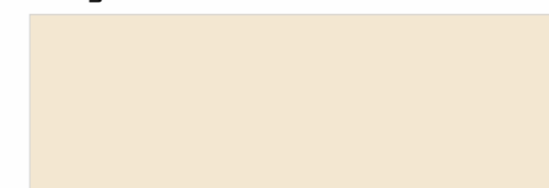

Choco



Walnut



Jaisalmer





# Marble Collection

Screpolato Nero



Statuario Volakas



Diamond Gold



Arabescato Gold



Natural Onyx



Super Statuario



Timeless Calacatta Borghini



Red Spider



Calacatta Gold



Terrazzo Bianco



Prostone Ivory



Brazilian



Victoria Beige



Smart Crema

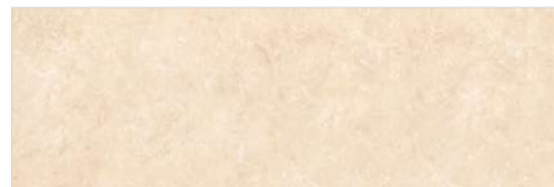

Breccia Beige



Dyna Crema



Mascara



Onyx Brown



Fusion Rose



Korso Brown



Onyx Rosso



Portofino Black



Copenhagen



Louise Green



Noir Desir



Roma Black

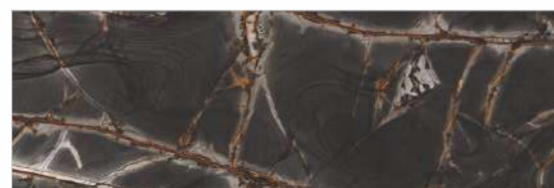

Portoro Gold



Portoro Black



Infinito Grey



Retrowood Black



Ambrato Nero



Saint Laurent



Fossil Brown



Coper Pearl



Roman Pearl



Choba



Metalix Blue



Volga Blue



Blue Agatha

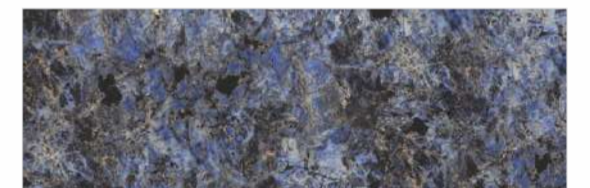

Arizona Blue



Sunshine Crystal

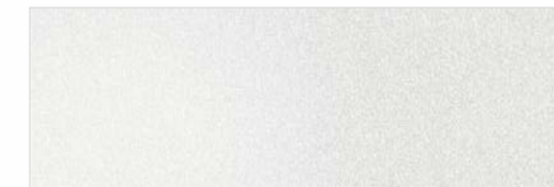

Sunshine Crystal Black



Sunshine Fancy

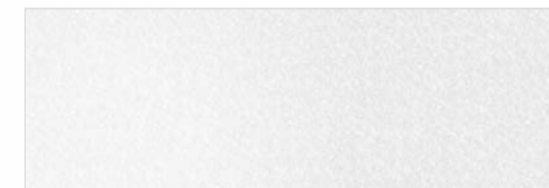

Sunshine Fancy Black

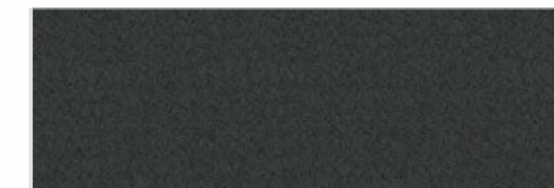

Orion White

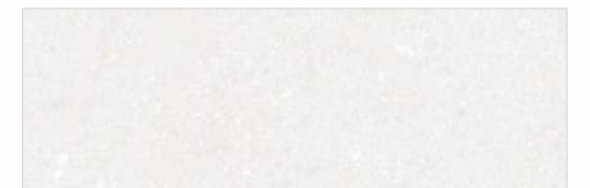

Orion Grey

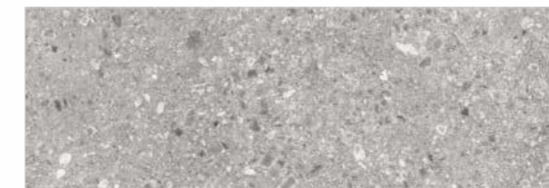

Orion Nero

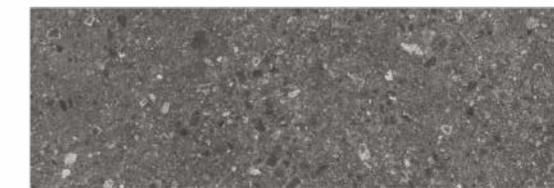

Victoria Beige



Natural Marfil



Fontana Crema



Rosalia Gold



The collections draw their inspiration from asymmetrical forms of nature, classic ceramic patterns, and modern lifestyle design sensibilities offering surface redefining the narrative of luxury, innovative designs, and utility altogether.



# SNP Collection

A ceramic classic, the SNP Collection revives the timeless pattern of sprinkled salt & pepper in its collection for an ageless look.

**ERIC**  
REDEFINED BEAUTY

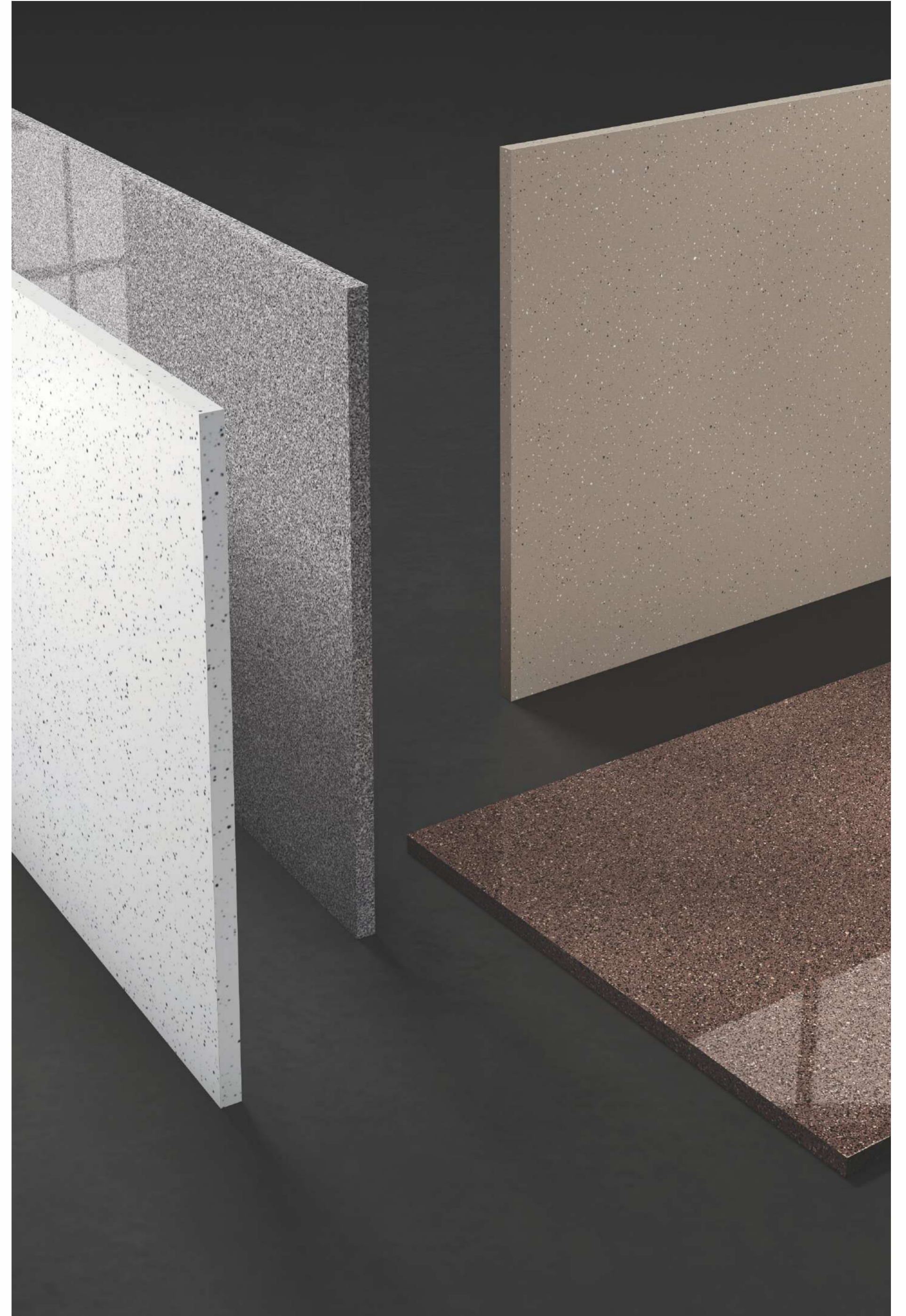





Table  
**Royal Quartz**

Floor & Wall  
**SNP Black**



**FULL BODY**  
SERIES

Royal Quartz

Finish : **Glossy & Matt**  
Body : **Full Body**  
Thickness: **15mm**

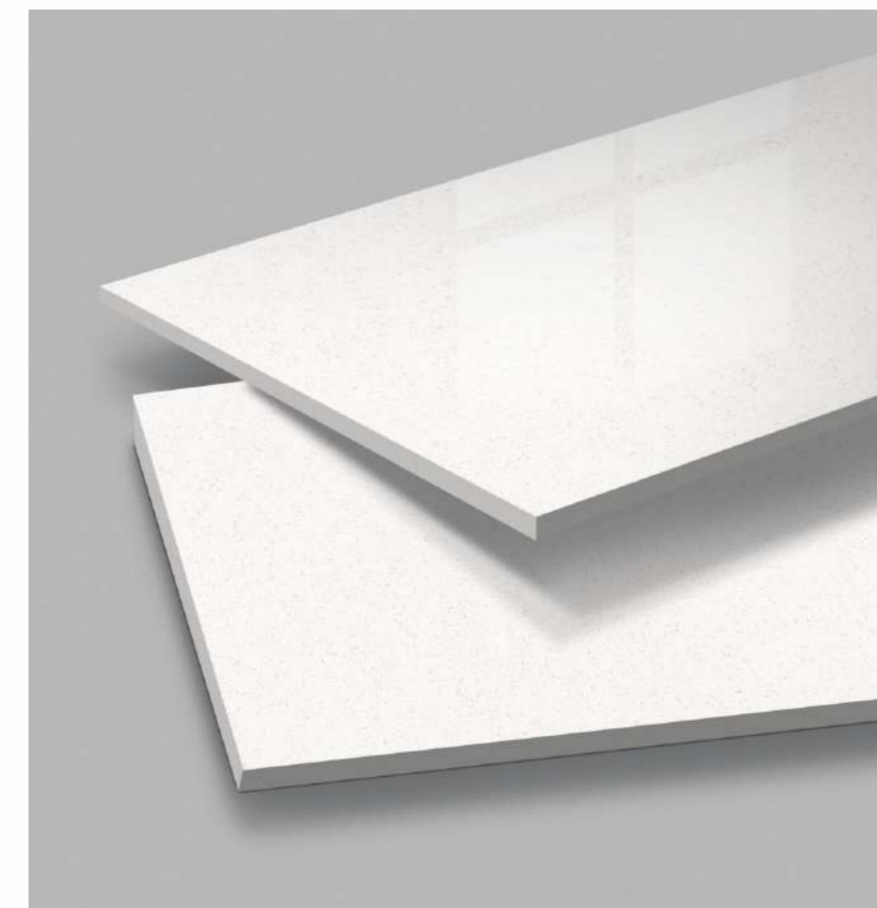

**800x3000mm | 800x2400mm**

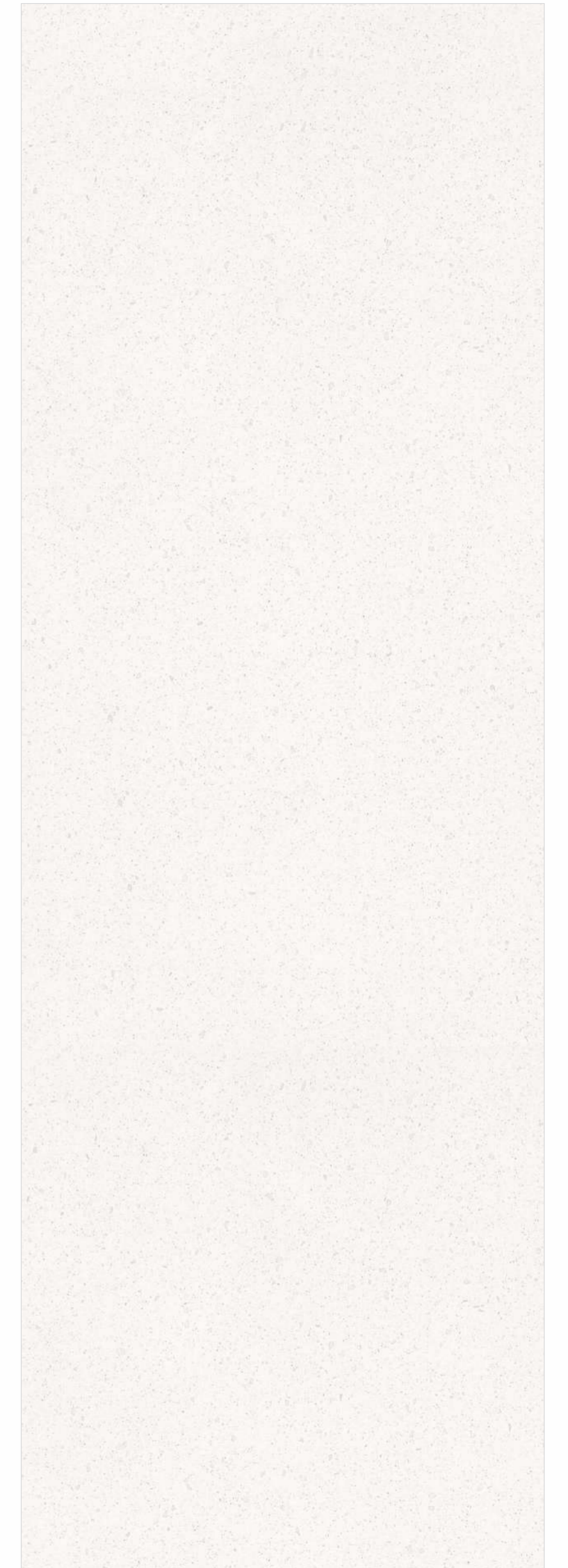

Italian Technology | FLEXIBLE BODY





Table Top  
**Galaxy White**

Floor  
**SNP Grey**



**FULL BODY**  
SERIES

**Galaxy White**

Finish : **Glossy & Matt**  
Body : **Full Body**  
Thickness: **15mm**

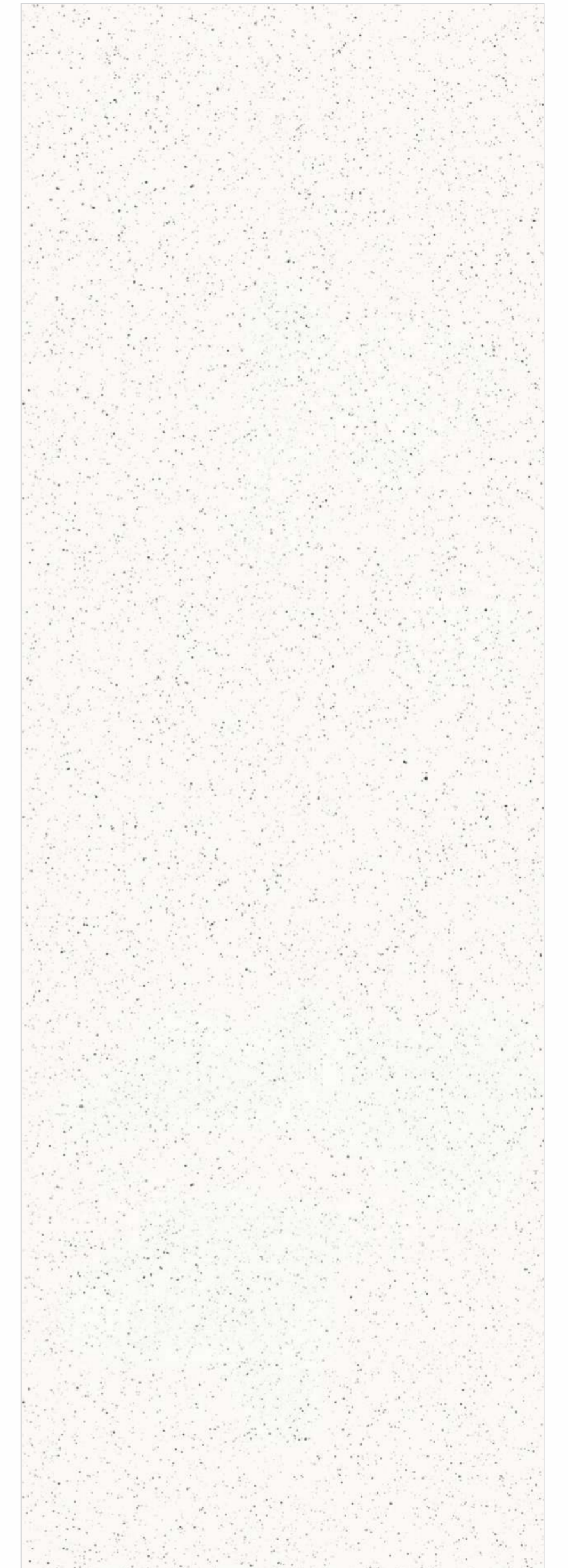

**800x3000mm | 800x2400mm**

Italian Technology |  **FLEXIBLE BODY**





Floor & Wall  
**Roma White**

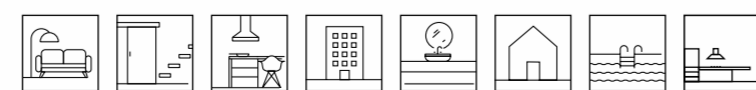

**FULL BODY**  
SERIES

Roma White

Finish : **Glossy & Matt**  
Body : **Full Body**  
Thickness: **15mm**

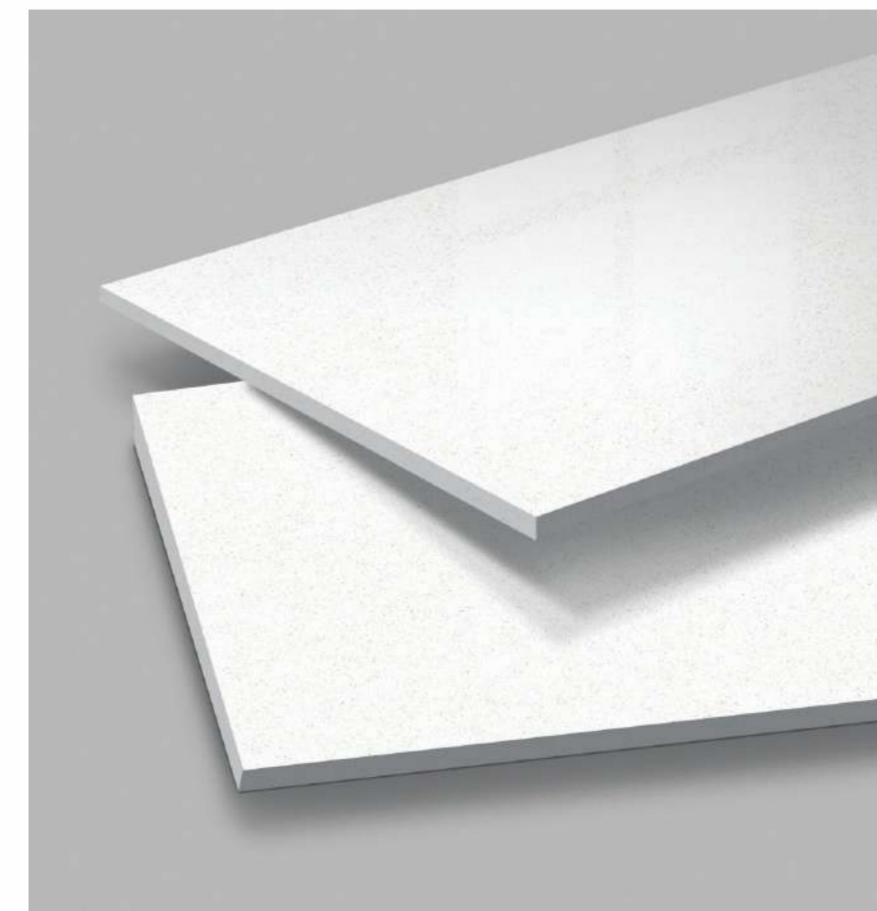

**800x2400mm**

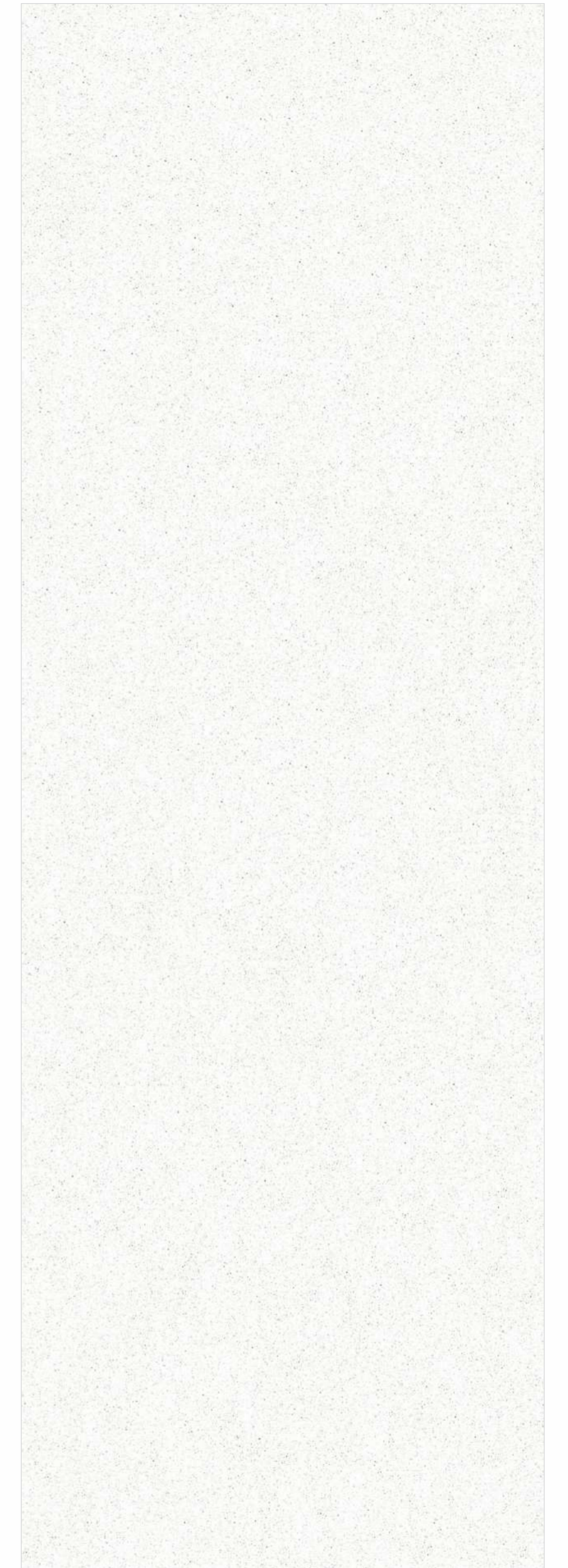





Floor  
**Galaxy Ivory**

Table  
**SNP Verde**

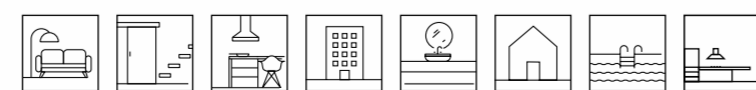

**FULL BODY**  
SERIES

**Galaxy Ivory**

Finish : **Glossy & Matt**  
Body : **Full Body**  
Thickness: **15mm**



**800x2400mm**

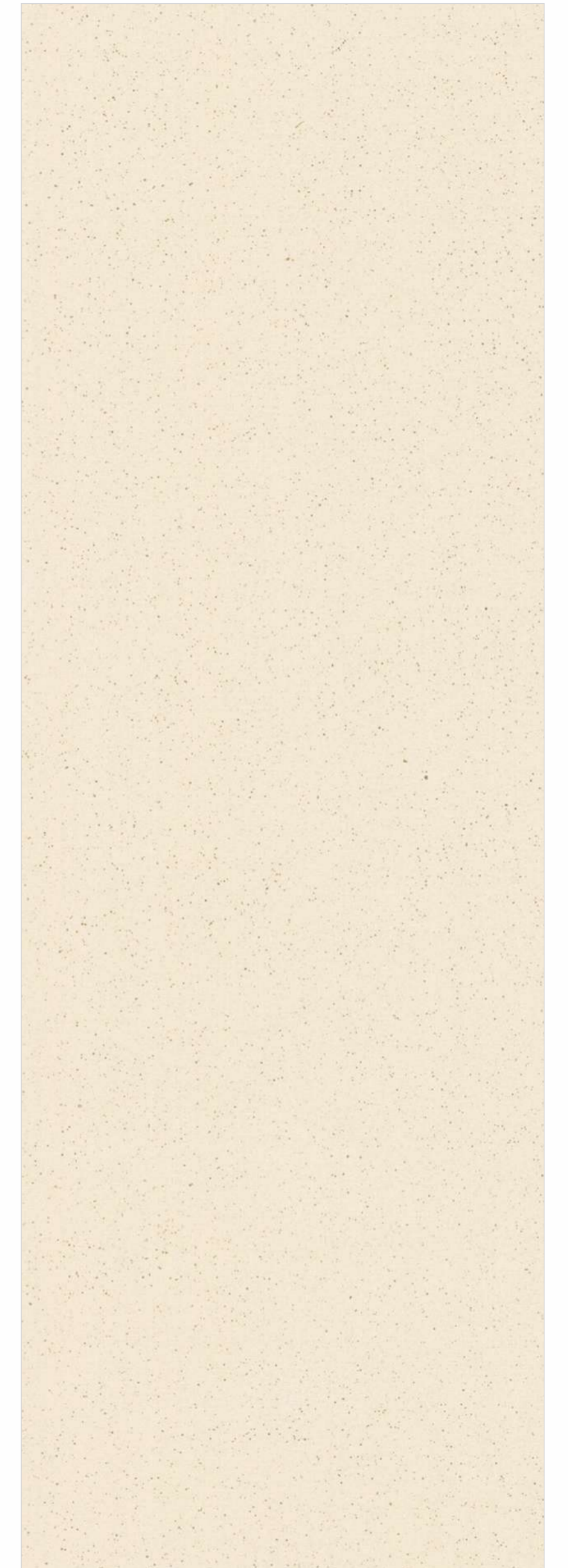





Island Platform  
**SNP Brown**

Floor & Wall  
**Steel Grey**

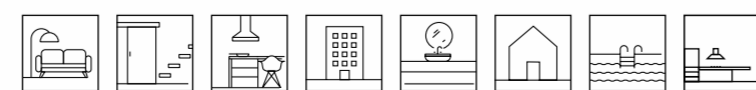

**FULL BODY**  
SERIES

**SNP Brown**

Finish : **Glossy & Matt**  
Body : **Full Body**  
Thickness: **15mm**



**800x2400mm**







Floor & Wall  
**SNP Beige**

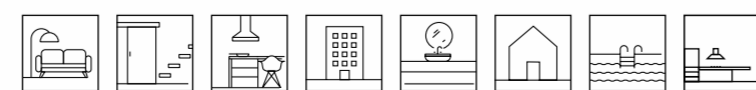

**FULL BODY**  
SERIES

SNP Beige

Finish : **Glossy & Matt**  
Body : **Full Body**  
Thickness: **15mm**



**800x2400mm**







Stairs  
**SNP Verde**

Floor  
**SNP Verde**

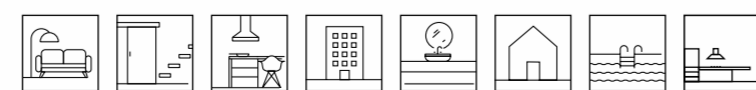

**FULL BODY**  
SERIES

**SNP Verde**

Finish : **Glossy & Matt**  
Body : **Full Body**  
Thickness: **15mm**



**800x2400mm**







Table  
**SNP Grey**

Floor  
**SNP Black**



**FULL BODY**  
SERIES

**SNP Grey**

Finish : **Glossy & Matt**  
Body : **Full Body**  
Thickness: **15mm**

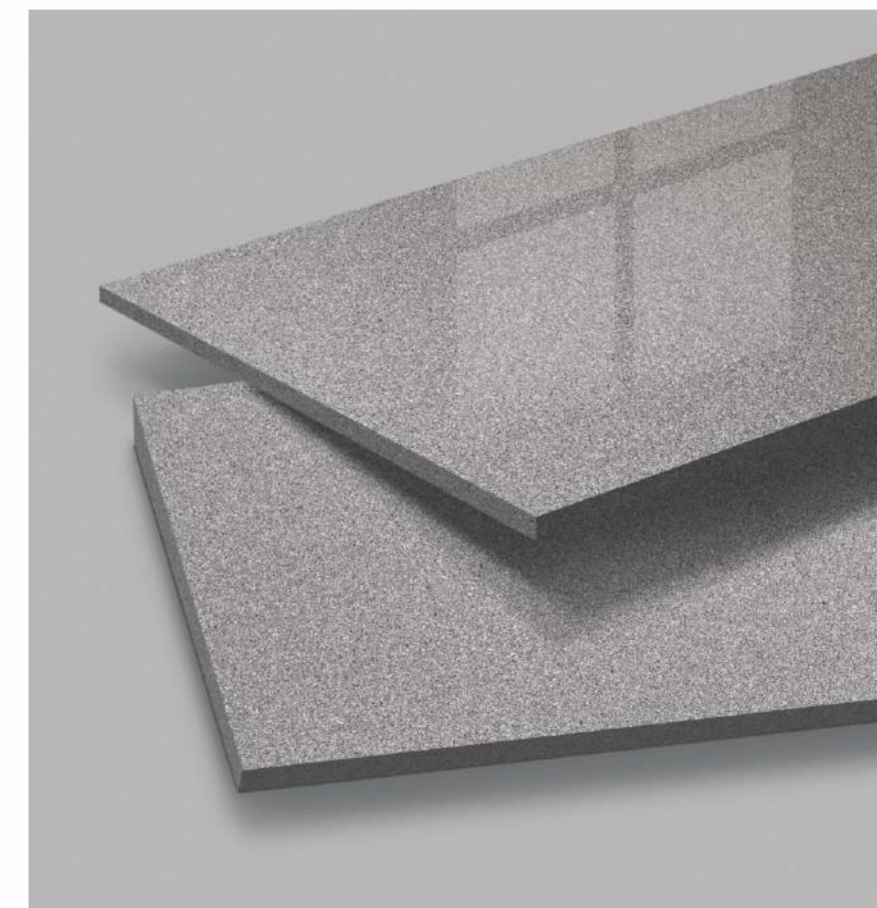

**800x2400mm**

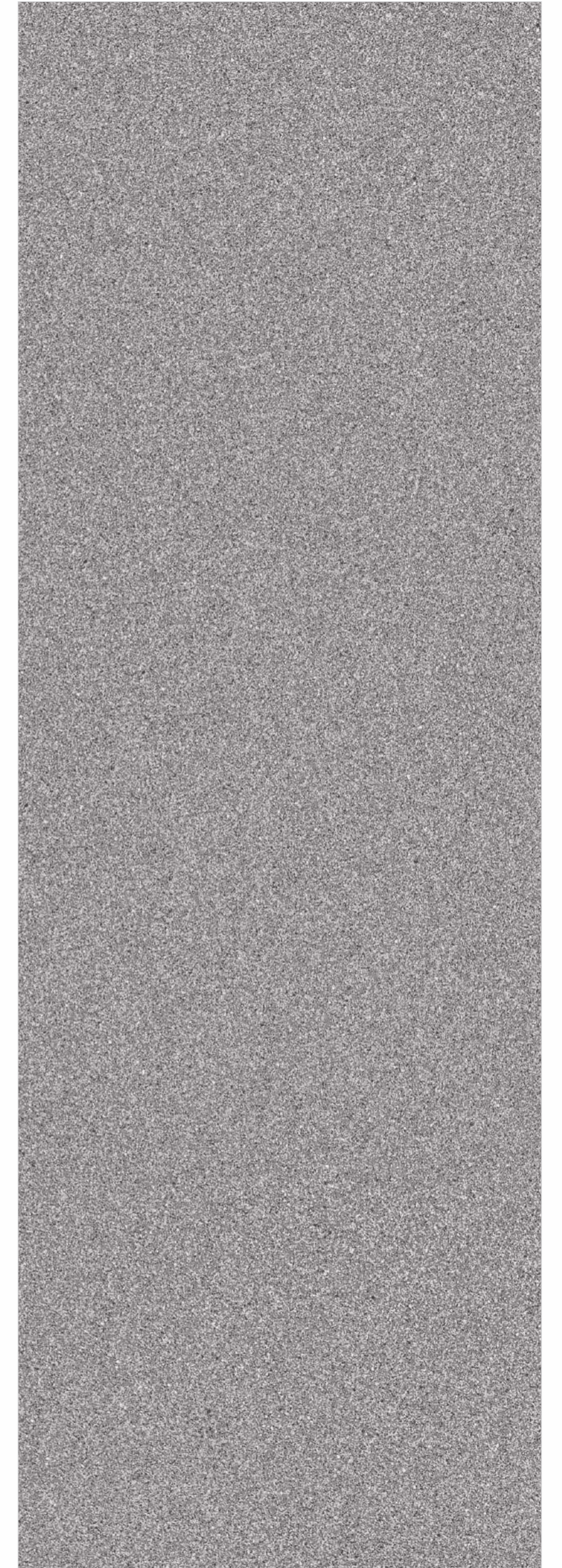





Vanity Top & Wall  
**SNP Black**

Floor  
**Galaxy White**

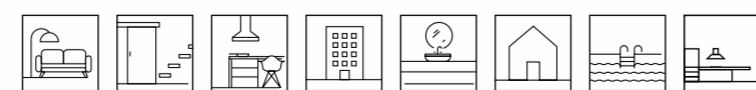

**FULL BODY**  
SERIES

**SNP Black**

Finish : **Glossy & Matt**  
Body : **Full Body**  
Thickness: **15mm**

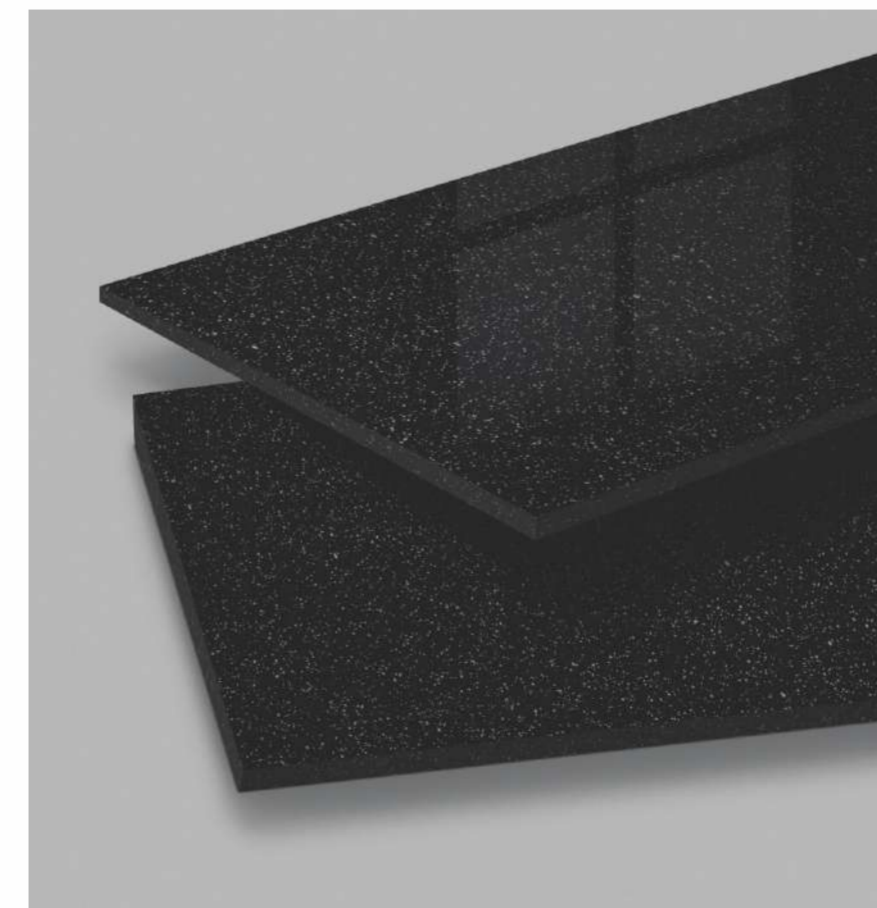

**800x2400mm**

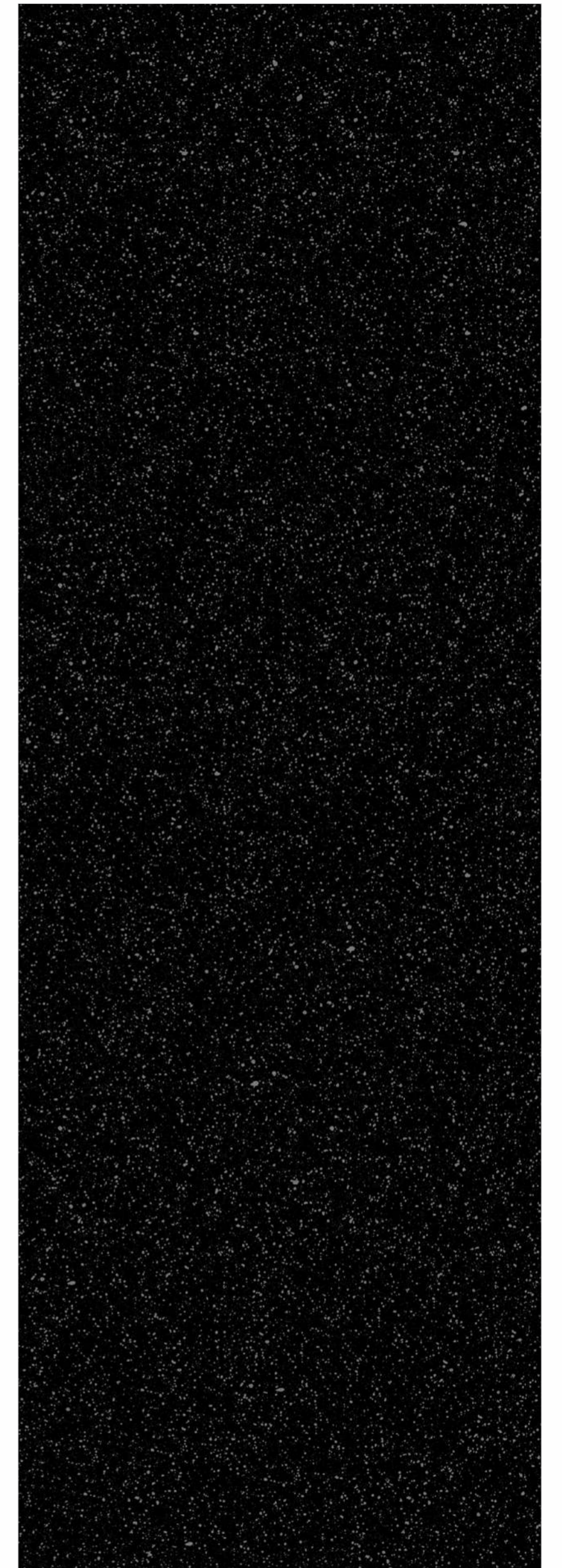



# Plain Collection

**ERIC**<sup>®</sup>  
REDEFINED BEAUTY

Discover never-fading solid colors for a modern  
ambiance with the Sintered Stones for

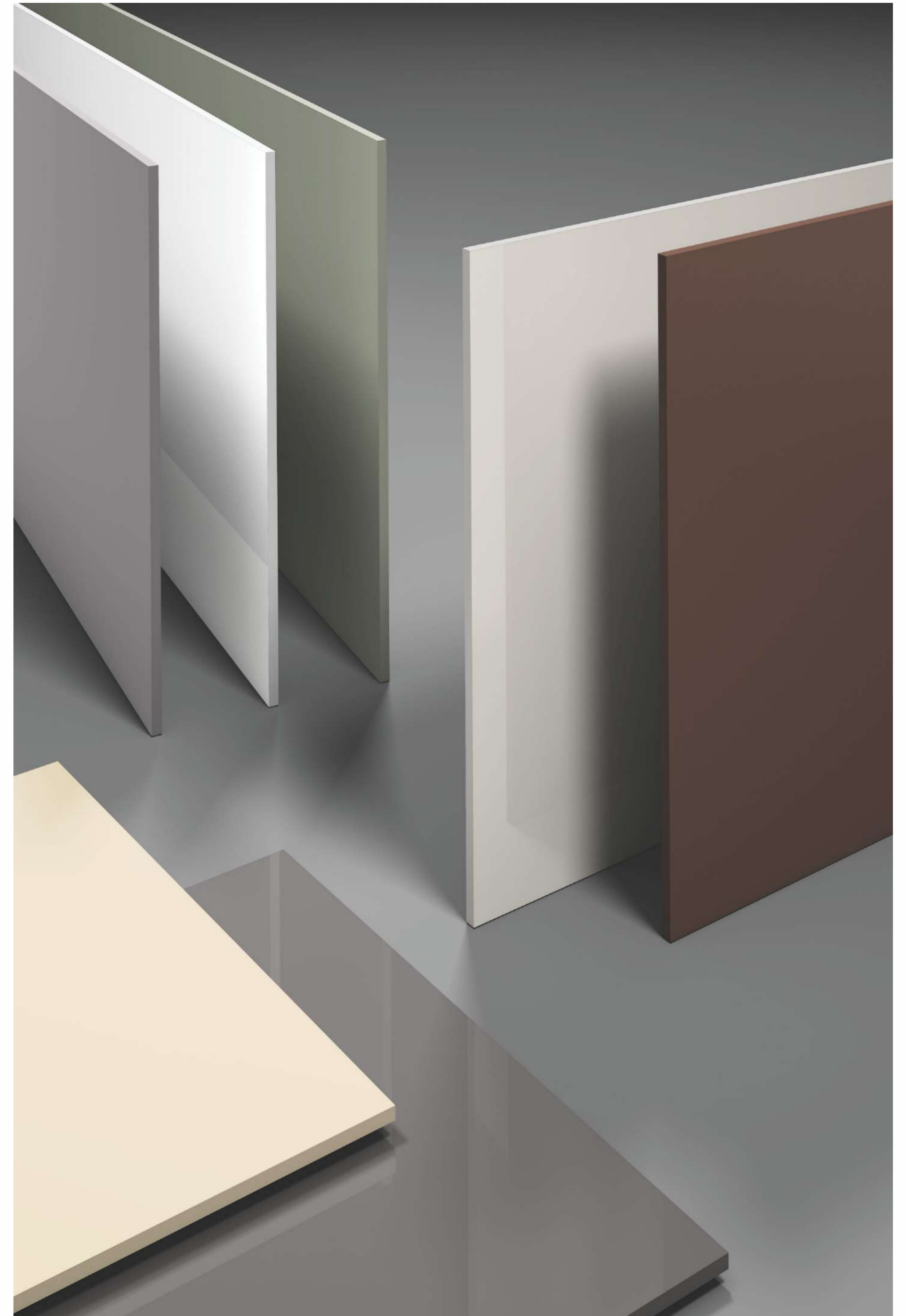





Floor & Wall  
**Nano White**

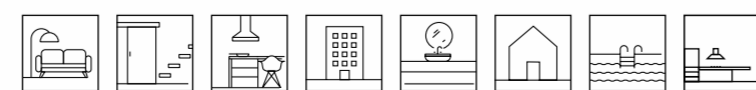

**FULL BODY**  
SERIES

**Nano White**

Available In  
Color Body  
**Crystal White**

Finish : **Glossy & Matt**  
Body : **Full Body**  
Thickness: **15mm**

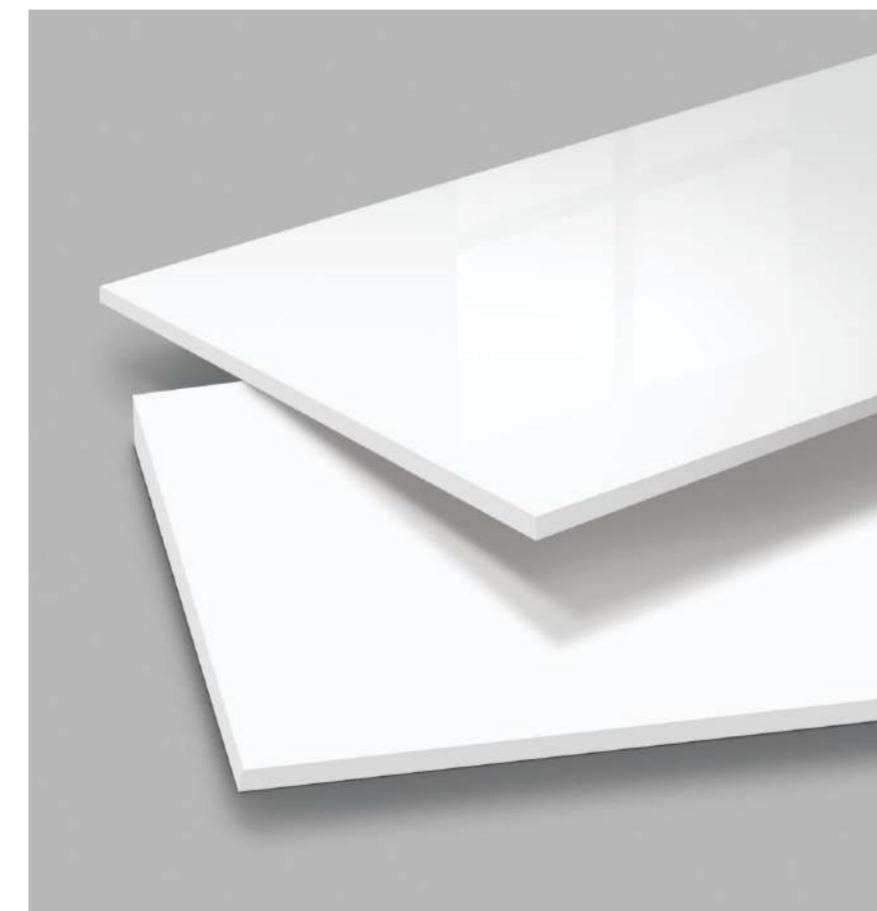

**800x3000mm | 800x2400mm**

Italian Technology |  **FLEXIBLE BODY**





Stairs **Nano Black**  
Floor **Arabescato Gold**

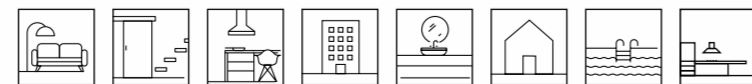

**FULL BODY**  
SERIES

**Nano Black**

Available In  
Color Body  
**Crystal Black**

Finish : **Glossy & Matt**  
Body : **Full Body**  
Thickness: **15mm**

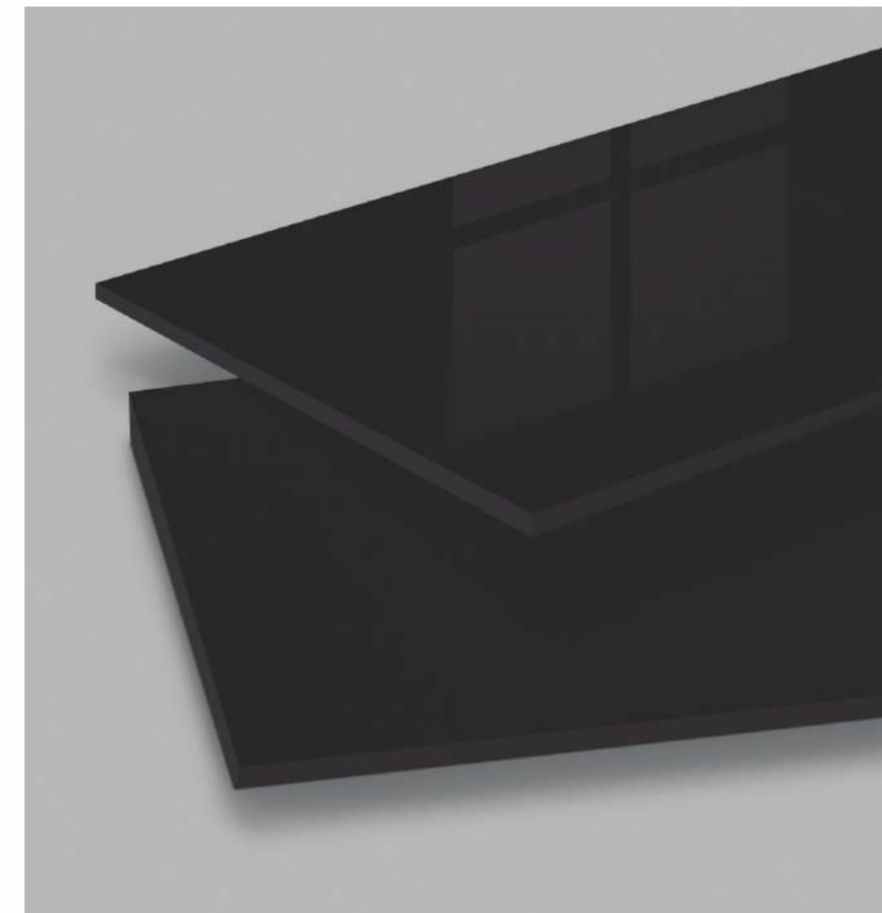

**800x3000mm | 800x2400mm**





Island Platform Top  
Light Grey

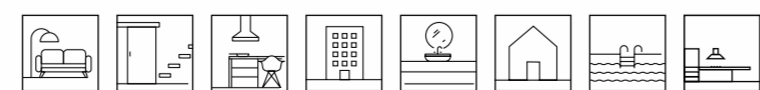

**FULL BODY**  
SERIES

Light Grey

Finish : **Glossy & Matt**  
Body : **Full Body**  
Thickness: **15mm**



**800x2400mm**







Counter Top  
**Steel Grey**

Floor  
**S&P Grey**

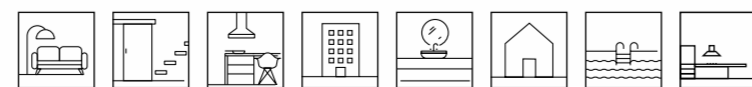

**FULL BODY**  
SERIES

**Steel Grey**

Finish : **Glossy & Matt**  
Body : **Full Body**  
Thickness: **15mm**

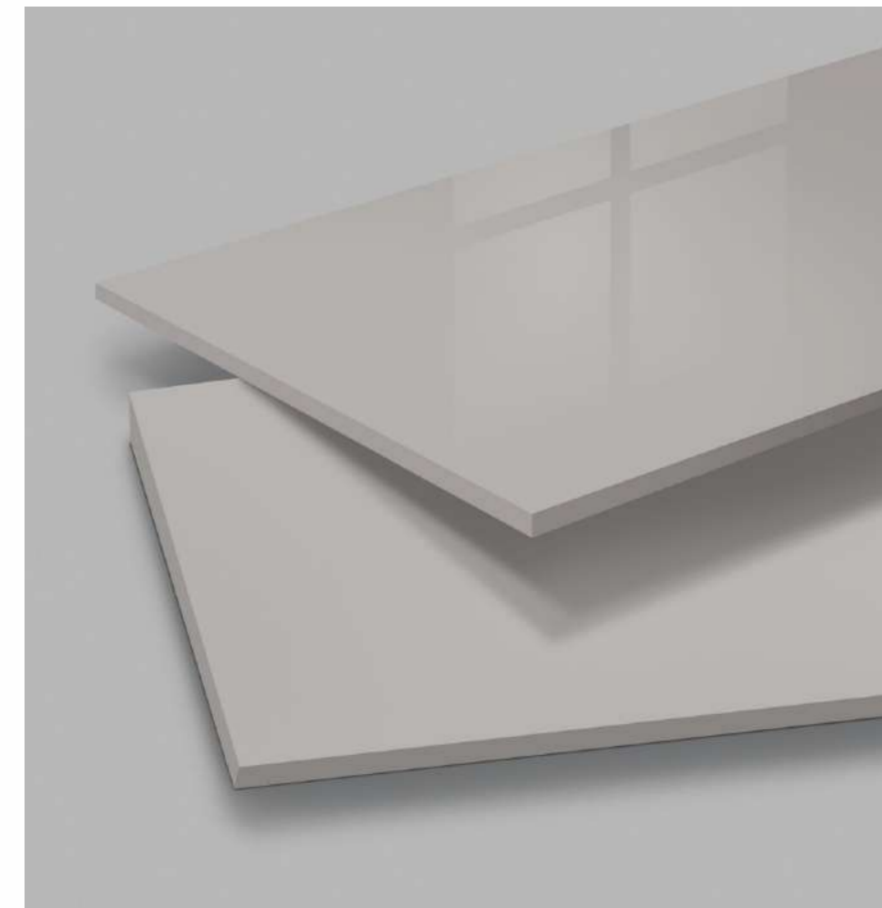

**800x3000mm | 800x2400mm**

Italian Technology |  **FLEXIBLE BODY**





Floor & Wall  
**Dark Grey**

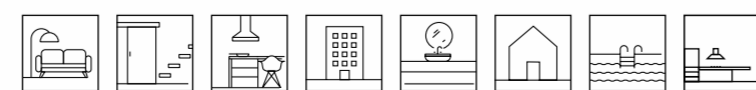

**FULL BODY**  
SERIES

**Dark Grey**

Finish : **Glossy & Matt**  
Body : **Full Body**  
Thickness: **15mm**

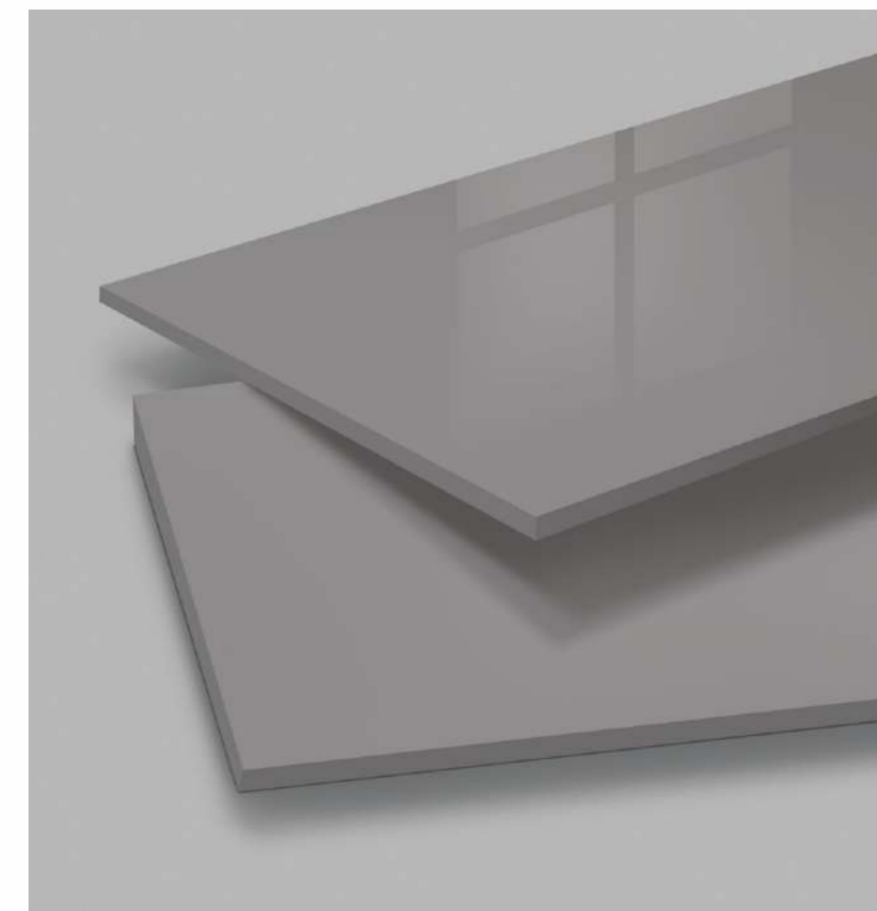

**800x2400mm**







A Wine &  
Infusion Lounge

**FULL BODY**  
SERIES

Fossil Grey

Finish : **Glossy & Matt**  
Body : **Full Body**  
Thickness: **15mm**

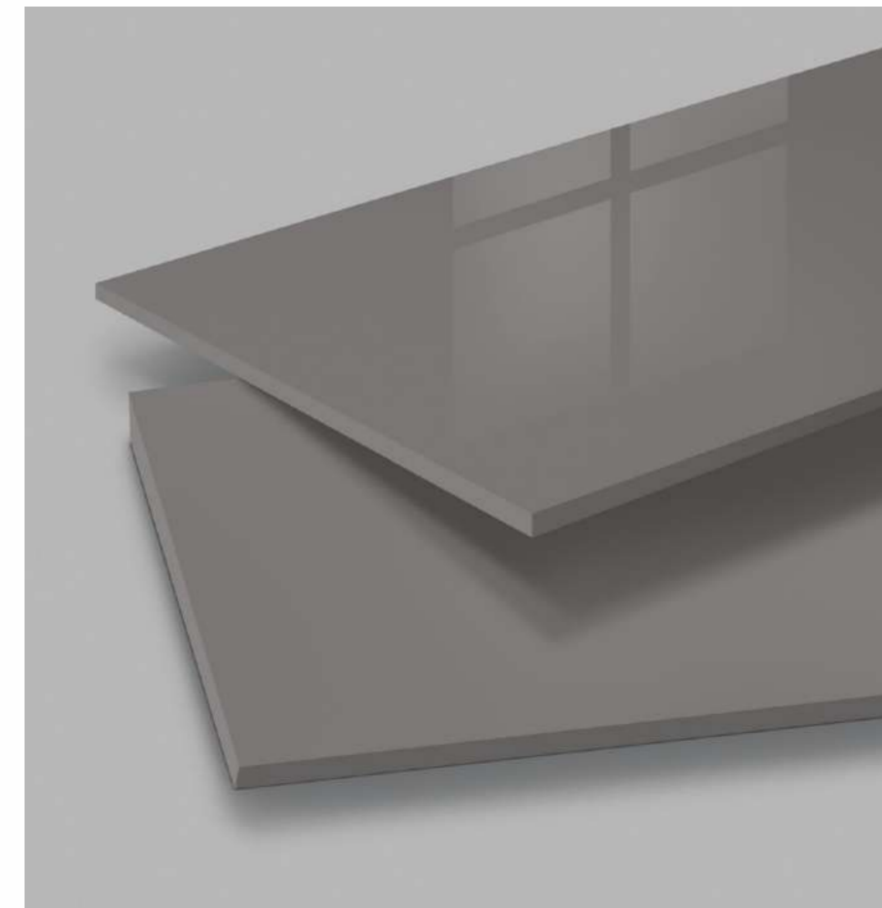
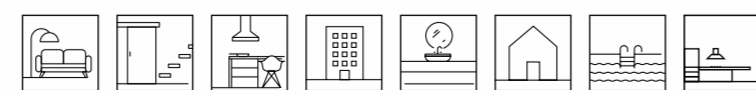

Table  
**Fossil Grey**

Floor & Wall  
**Steel Grey**



**800x3000mm | 800x2400mm**

Italian Technology | **FLEXIBLE BODY**





Floor  
**Kotta**

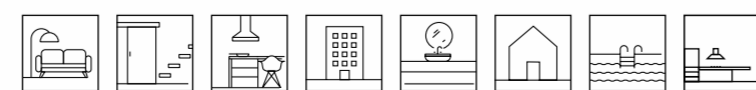

**FULL BODY**  
SERIES

**Kotta**

Finish : **Glossy & Matt**  
Body : **Full Body**  
Thickness: **15mm**

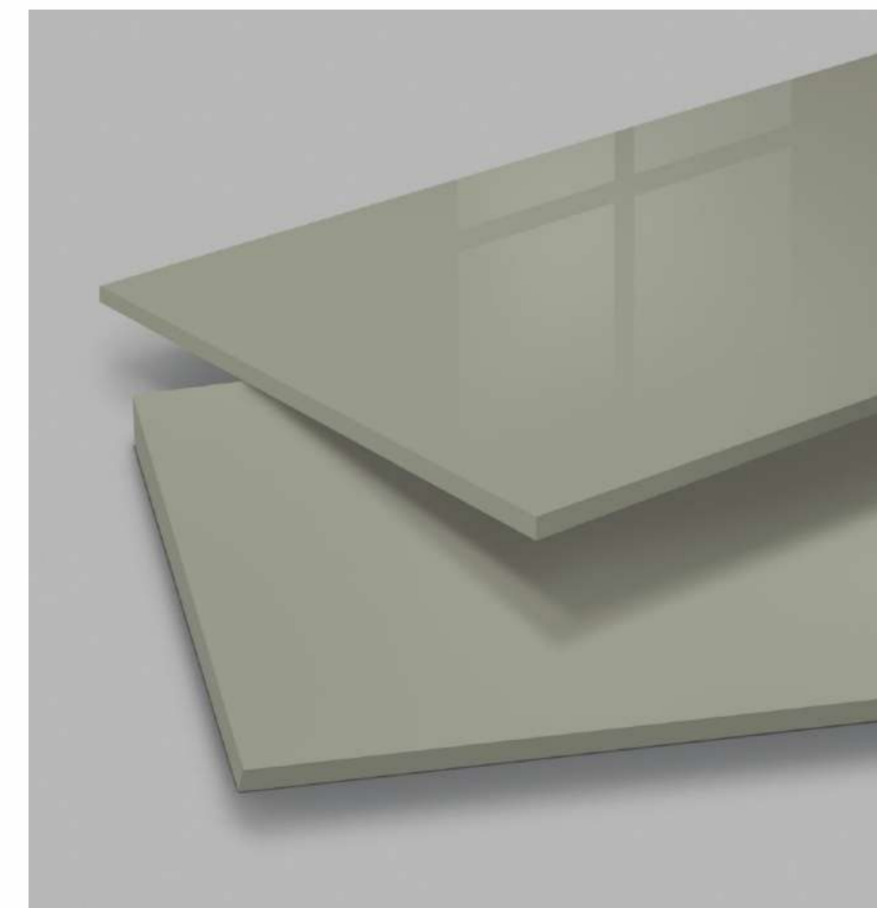

**800x2400mm**





Table  
Ivory

Wall  
Ivory

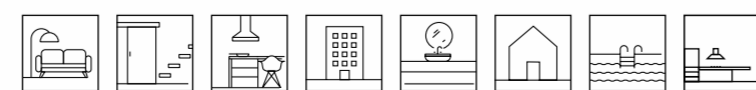

**FULL BODY**  
SERIES

Ivory

Finish : **Glossy & Matt**  
Body : **Full Body**  
Thickness: **15mm**

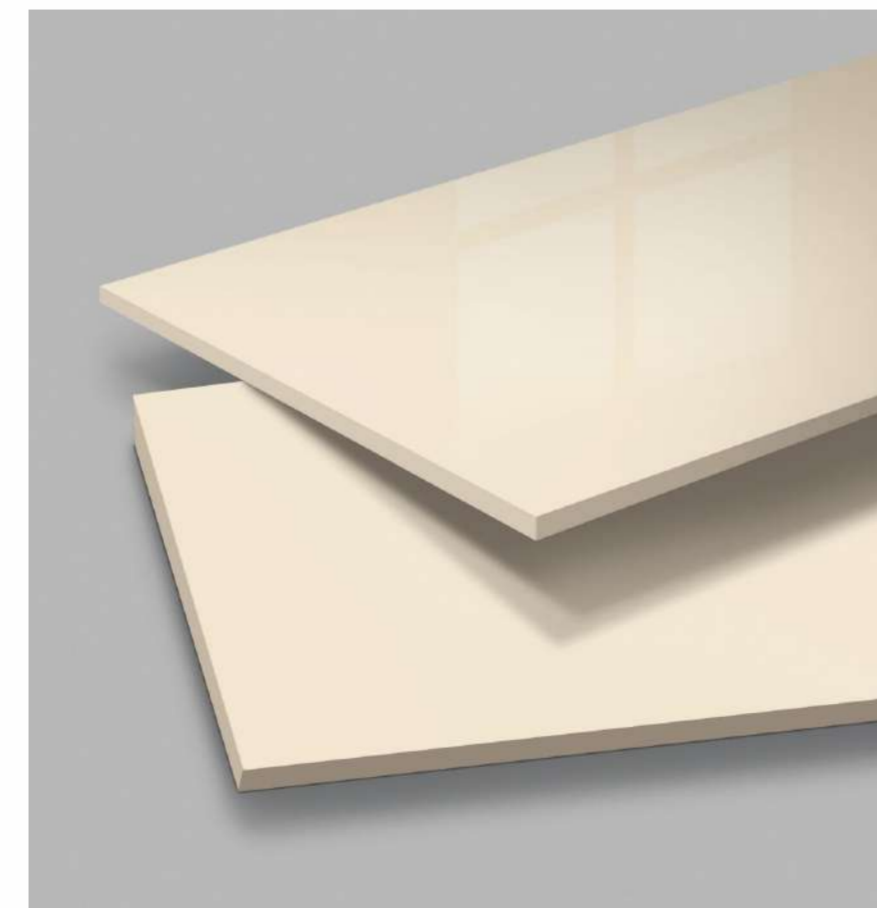

**800x2400mm**

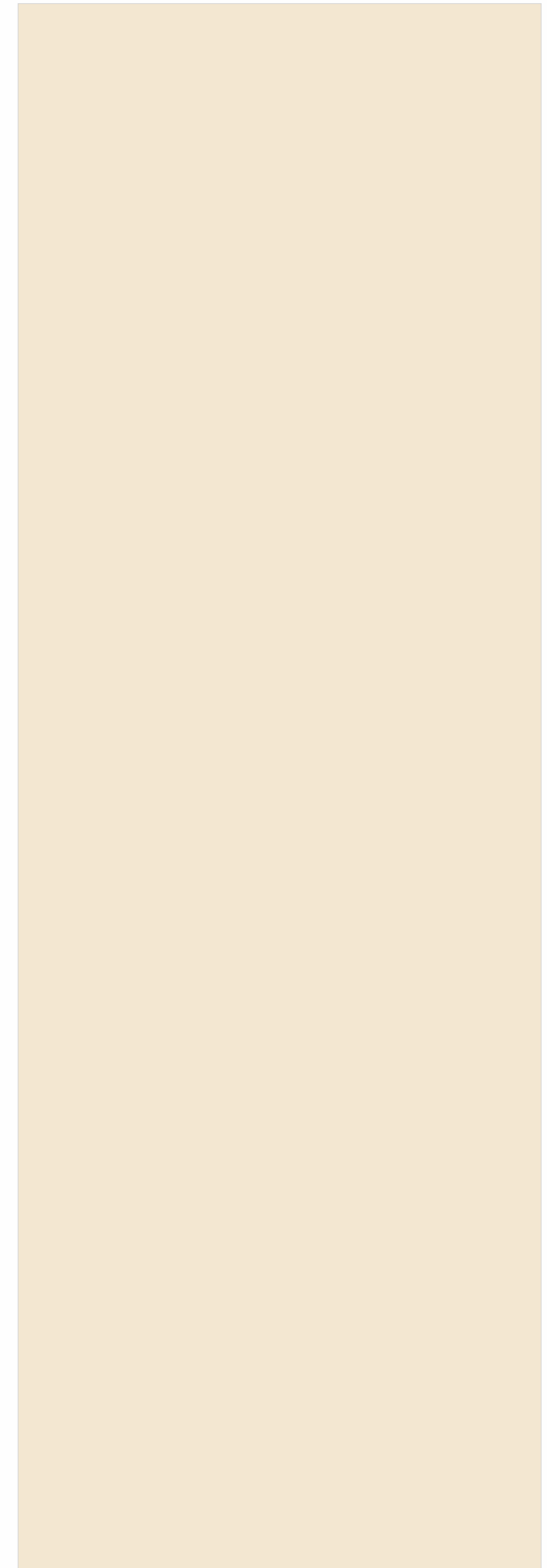





Stairs Floor  
Choco Fossil Grey

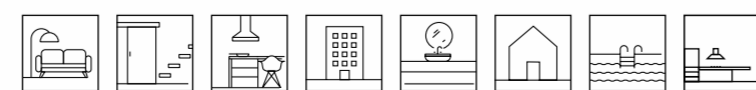

**FULL BODY**  
SERIES

Choco

Finish : **Glossy & Matt**  
Body : **Full Body**  
Thickness: **15mm**

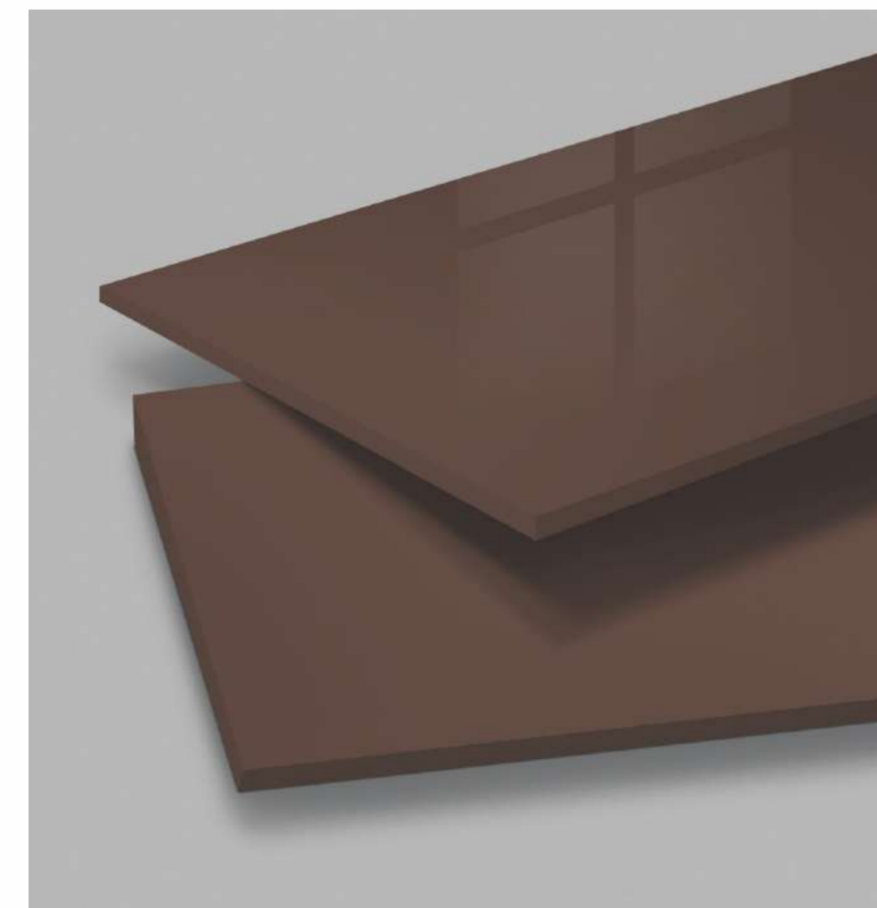

**800x2400mm**







Wall & Vanity  
**Walnut**

Floor  
**Timeless Calacatta Borghini**

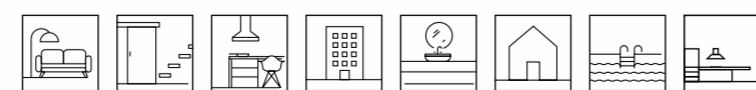

**FULL BODY**  
SERIES

Walnut

Finish : **Glossy & Matt**  
Body : **Full Body**  
Thickness: **15mm**

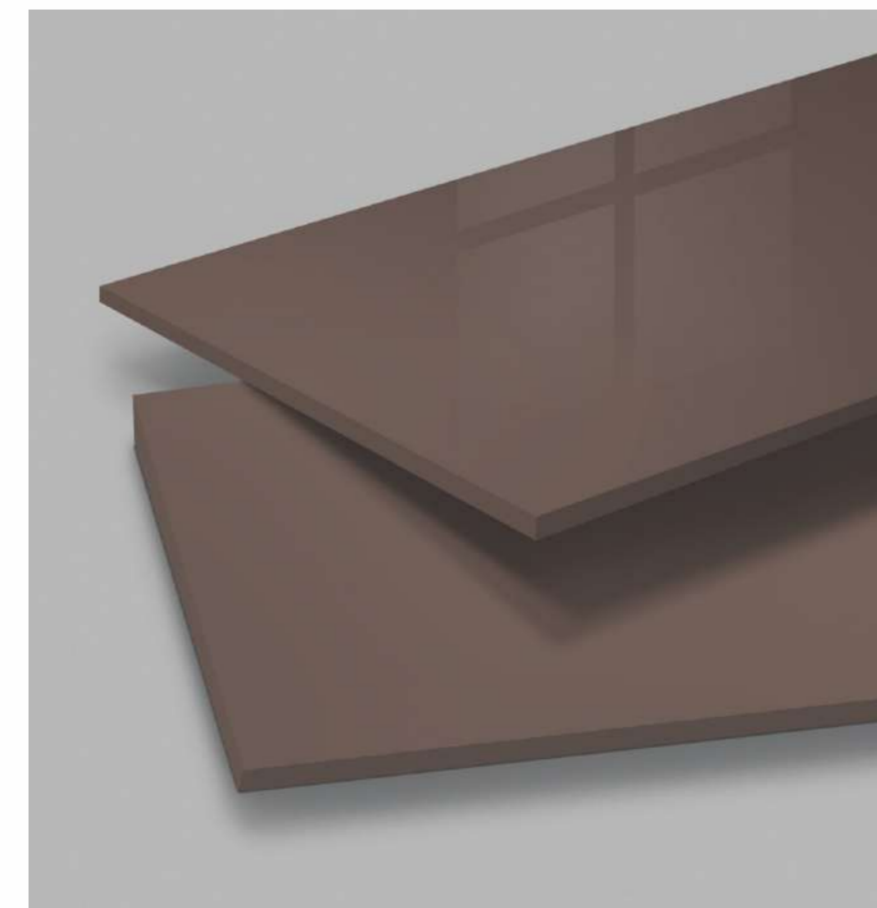

**800x3000mm | 800x2400mm**







**FULL BODY**  
SERIES

Jaisalmer

Finish : **Glossy & Matt**  
Body : **Full Body**  
Thickness: **15mm**

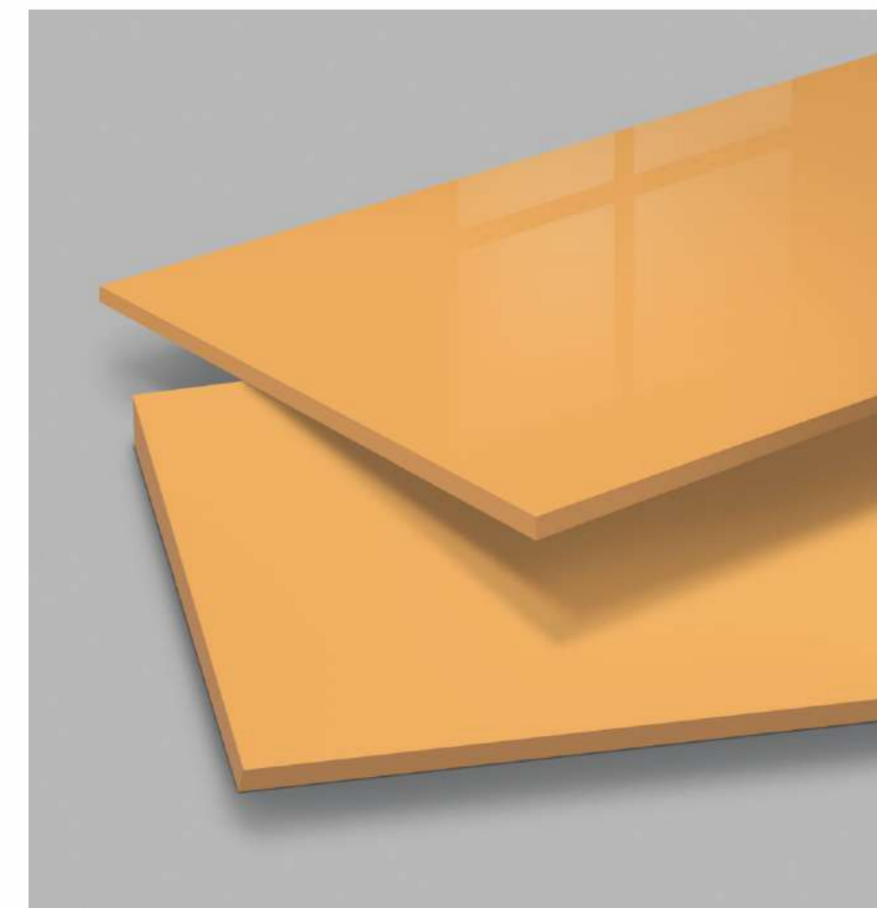

Stairs  
**Jaisalmer**

Wall  
**Jaisalmer**



**800x2400mm**

Italian Technology |  **FLEXIBLE BODY**



# Marble Collection

Taking cues from the exquisite design of marble,  
The Marble Collection masterfully recreates  
elegance less the limitations.

**ERIC**<sup>®</sup>  
REDEFINED BEAUTY

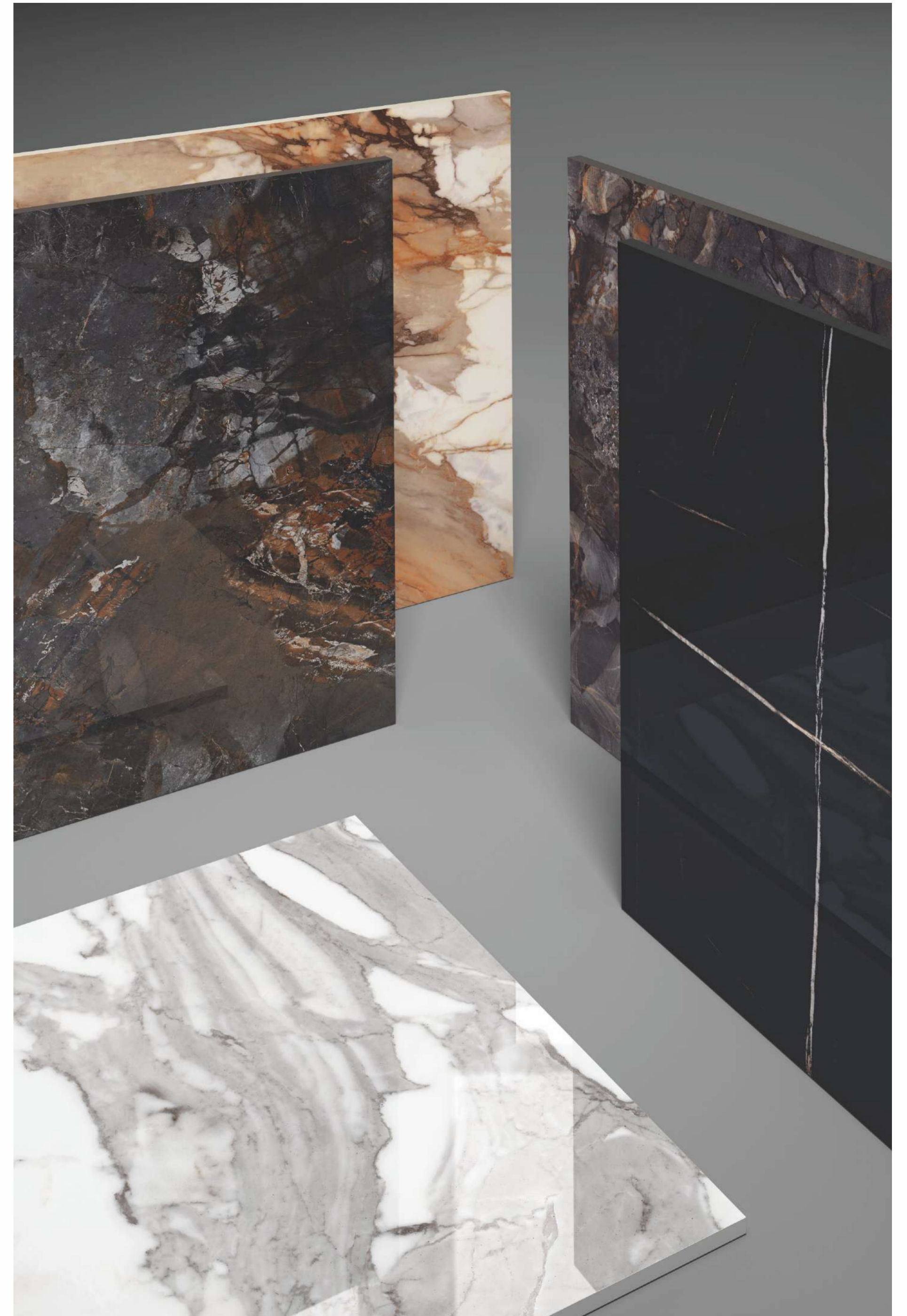





Island Platform  
Statuario Volakas

Floor & Wall  
Statuario Volakas



### Screpolato Nero

Finish : **Glossy**  
Random : **3**  
Body : **Color Body**  
Thickness: **15mm**



### Statuario Volakas

Finish : **Glossy**  
Endless: **3**  
Body : **Color Body**  
Thickness: **15mm**



**800x2400mm**

Italian Technology

FLEXIBLE BODY





Island Platform  
**Diamond Gold**

Floor & Wall  
**Diamond Gold**

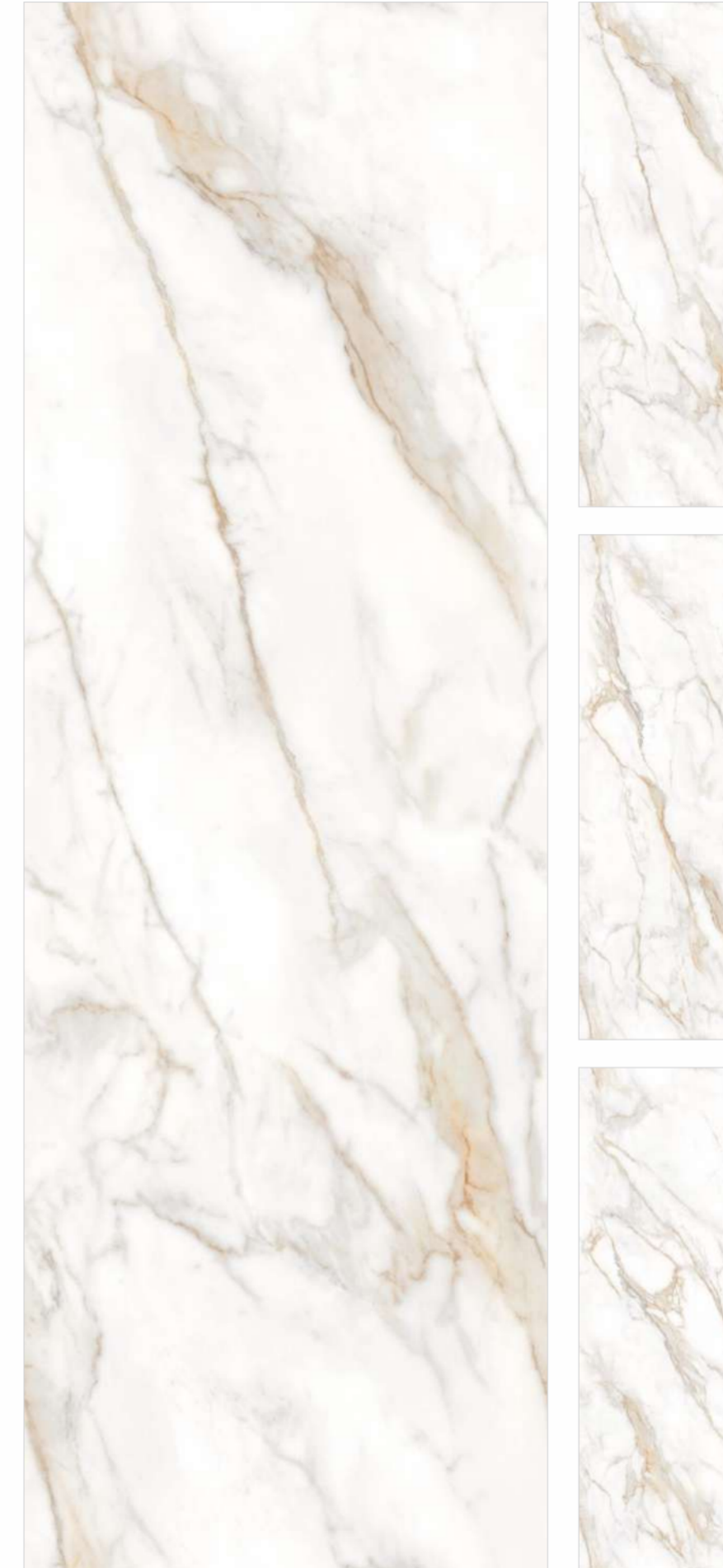
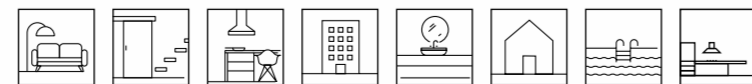

### Diamond Gold

Finish : **Glossy**  
Endless : **3**  
Body : **Color Body**  
Thickness: **15mm**

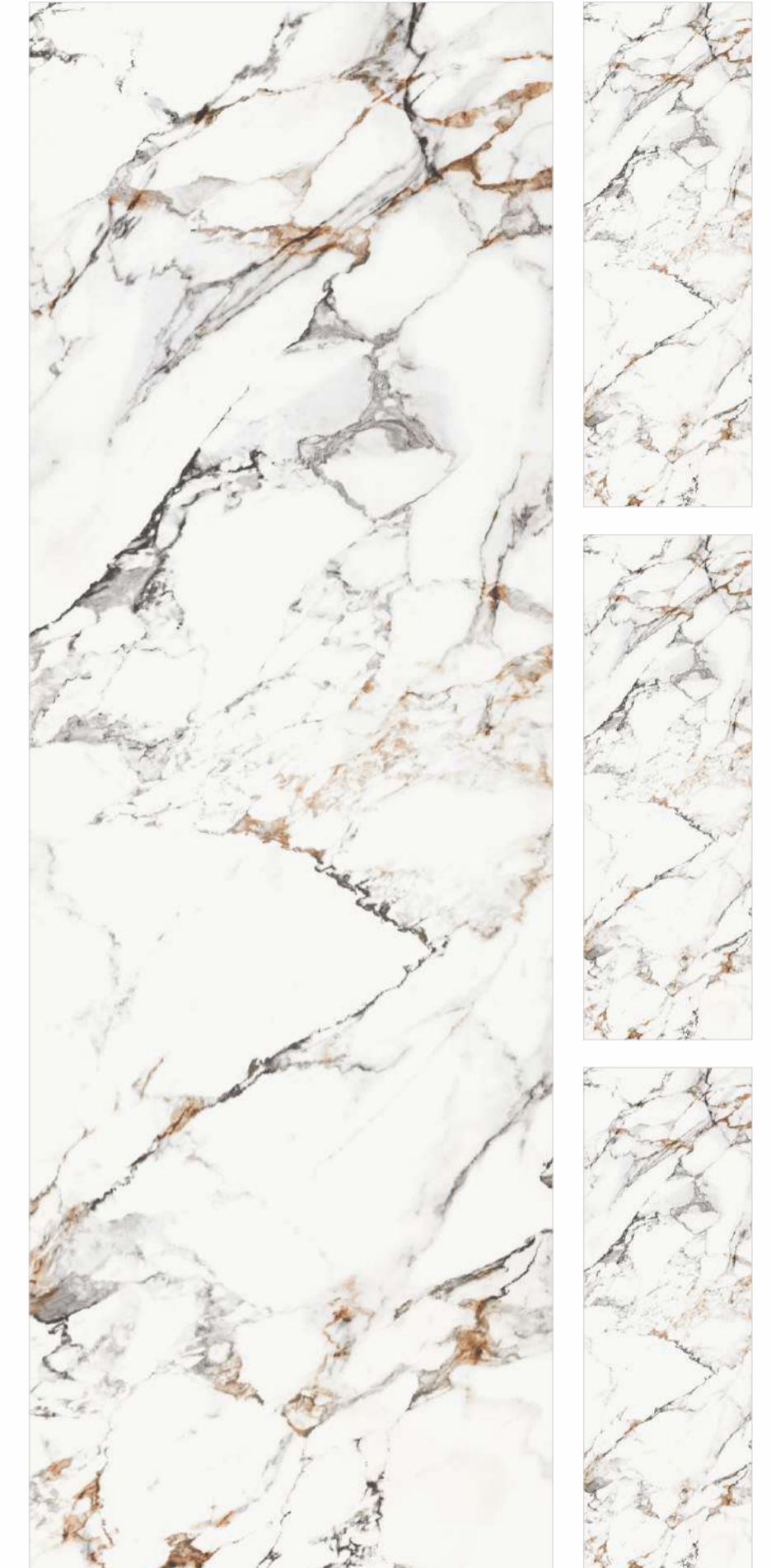

### Arabescato Gold

Finish : **Glossy**  
Body : **Color Body**  
Thickness: **15mm**



**800x2400mm**

Italian Technology

FLEXIBLE BODY



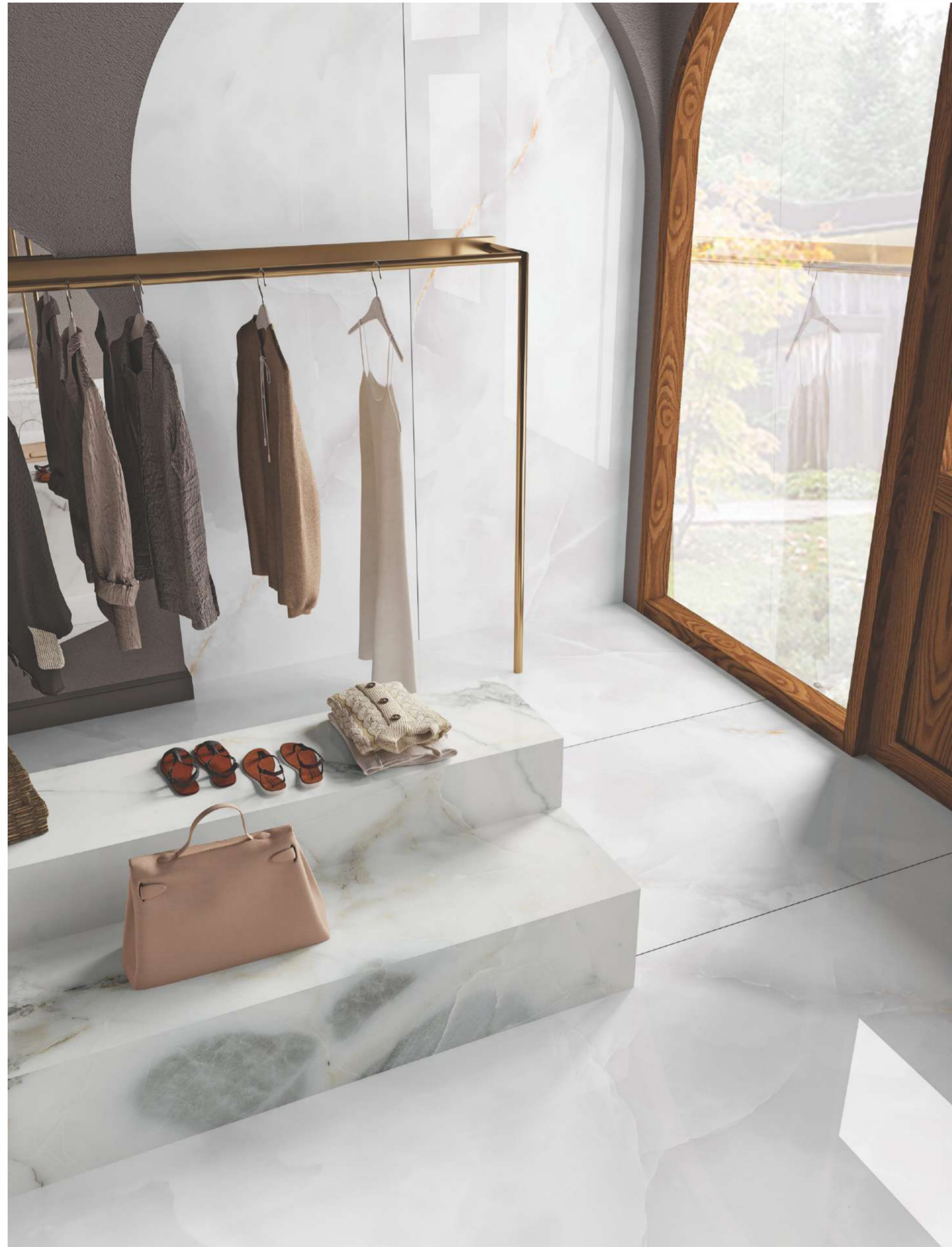

Floor & Wall  
**Natural Onyx**

Display Counter  
**Super Statuario**

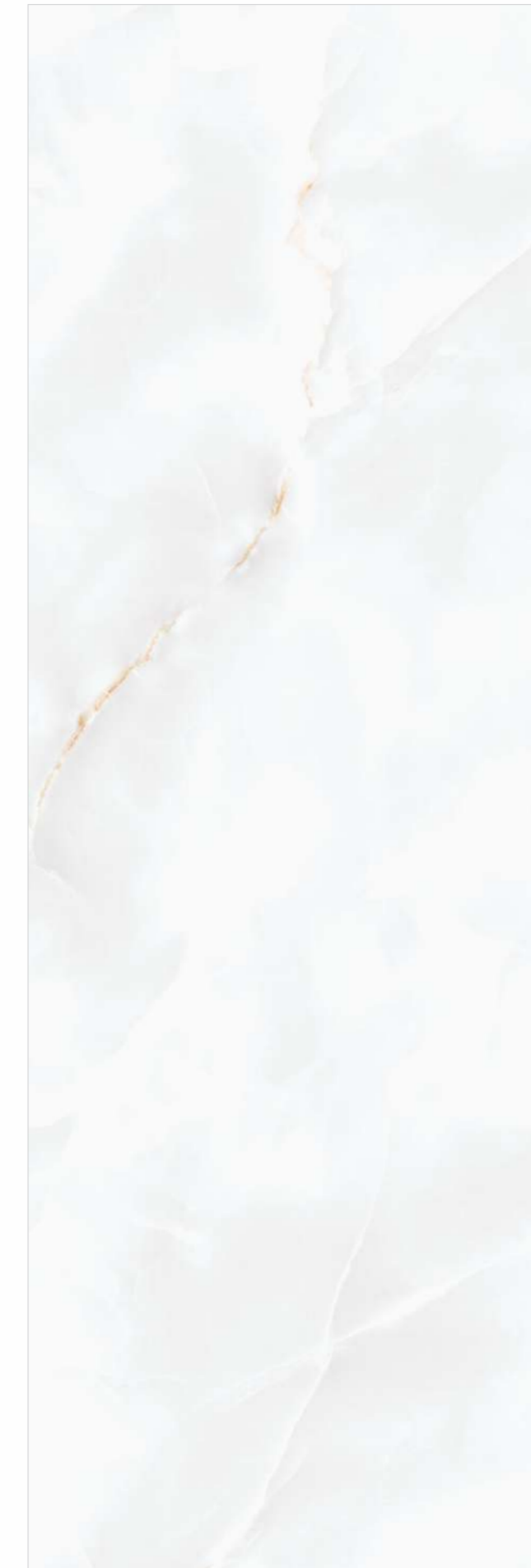
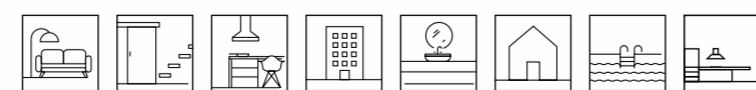

## Natural Onyx

Finish : **Glossy**  
Random : **3**  
Body : **Color Body**  
Thickness: **15mm**



**800x2400mm**

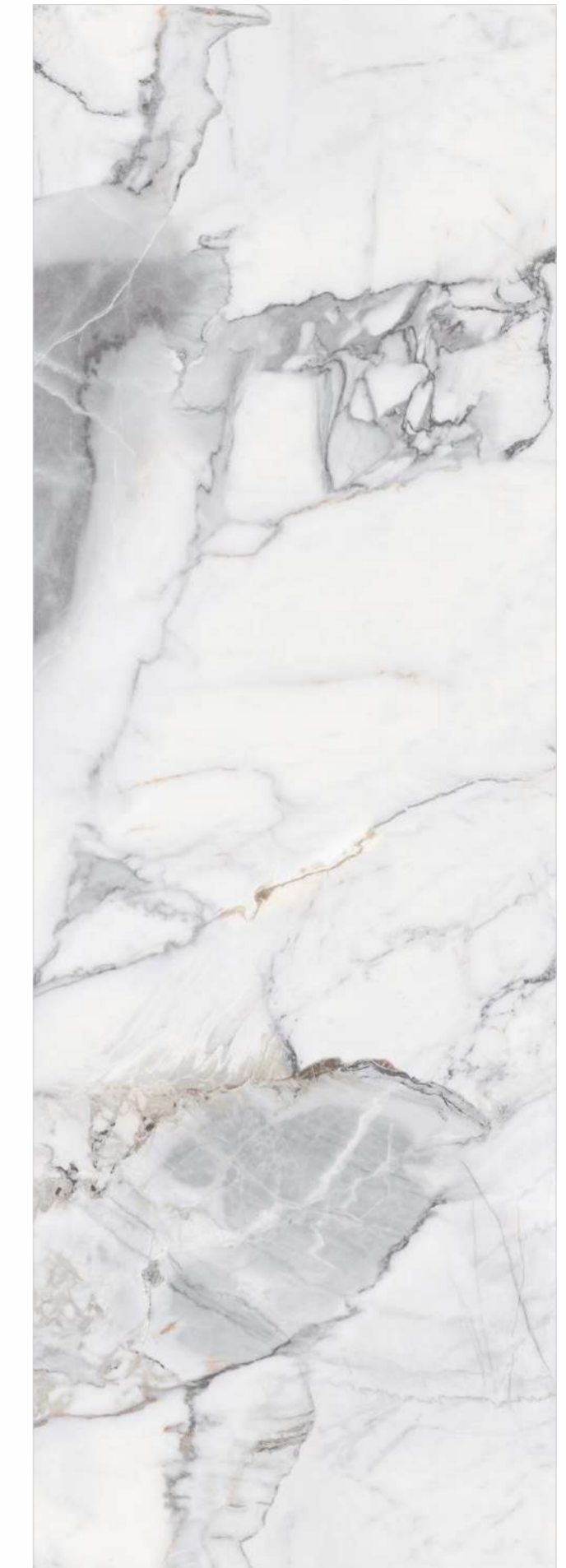

## Super Statuario

Finish : **Glossy**  
Random : **3**  
Body : **Color Body**  
Thickness: **15mm**







Stairs  
Timeless Calacatta Borghini

Wall  
Timeless Calacatta Borghini

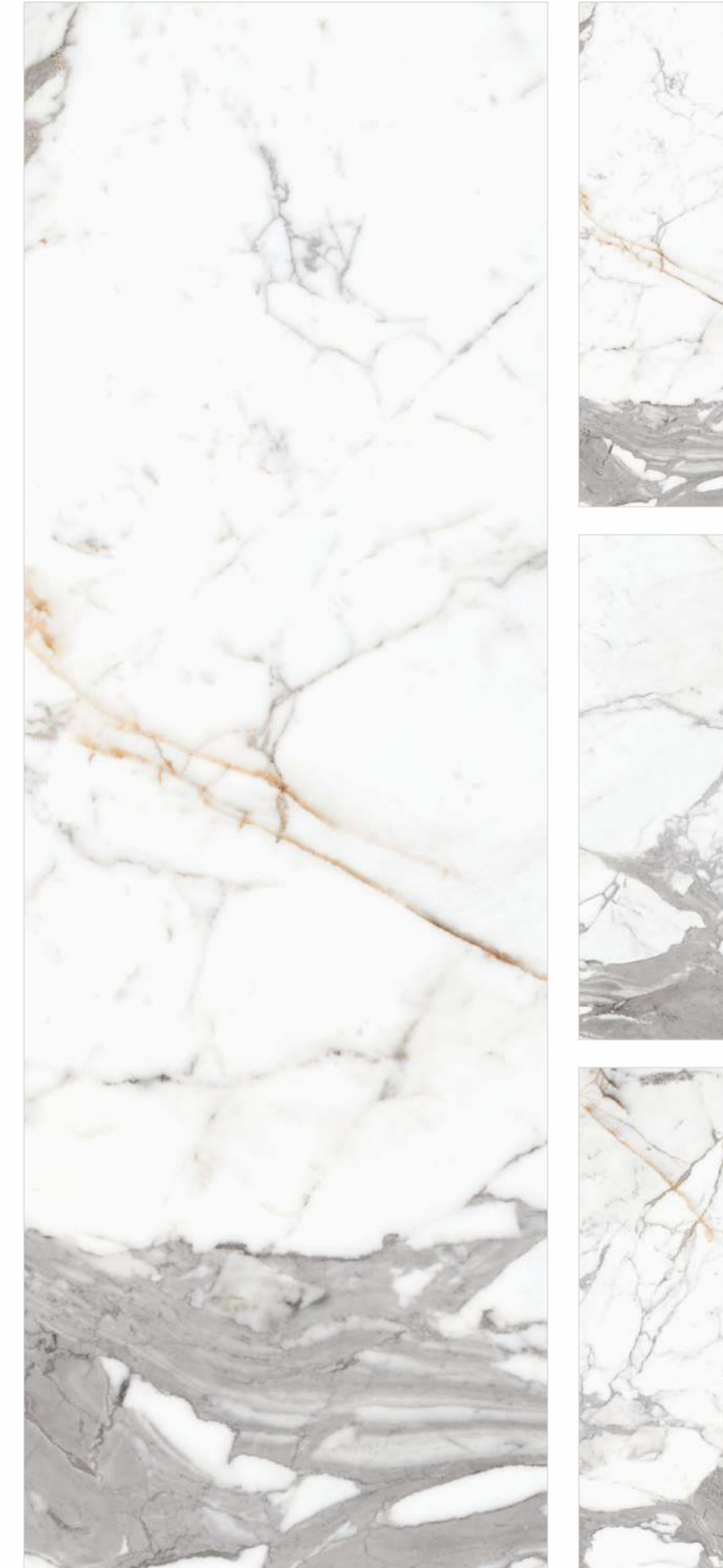
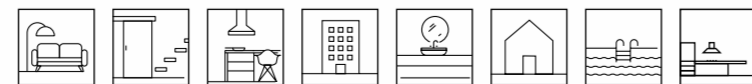

Timeless Calacatta Borghini

Finish : **Glossy**  
Continue : **3**  
Body : **Color Body**  
Thickness: **15mm**



**800x2400mm**



Red Spider

Finish : **Glossy**  
Endless : **2**  
Body : **Color Body**  
Thickness: **15mm**

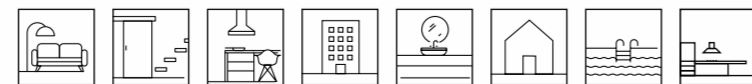





Table Top  
**Terrazzo Bianco**

Floor & Wall  
**Terrazzo Bianco**



**Calacatta Gold**

Finish : **Glossy**  
Random : **2**  
Body : **Color Body**  
Thickness: **15mm**



**800x2400mm**



**Terrazzo Bianco**

Finish : **Glossy**  
Random : **2**  
Body : **Color Body**  
Thickness: **15mm**







Island Platform  
Brazilian

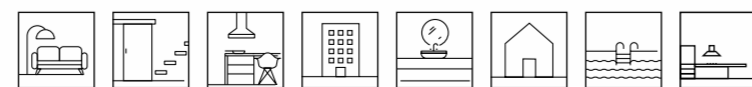

Prostone Ivory

Finish : Glossy  
Body : Color Body  
Thickness: 15mm



**800x2400mm**

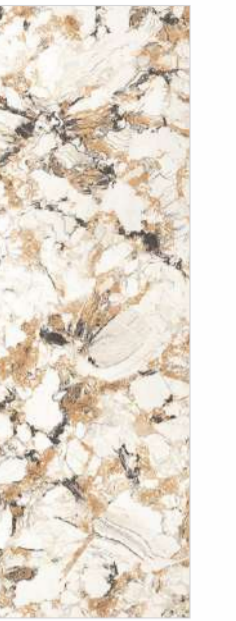

Brazilian

Finish : Glossy  
Body : Color Body  
Thickness: 15mm







Floor  
**Victoria Beige**

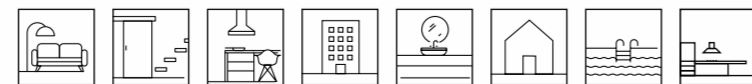

**Victoria Beige**

Finish : **Glossy**  
Random : **2**  
Body : **Color Body**  
Thickness: **15mm**



**800x2400mm**



**Smart Crema**

Finish : **Glossy**  
Random : **2**  
Body : **Color Body**  
Thickness: **15mm**







Floor & Wall  
**Breccia Beige**

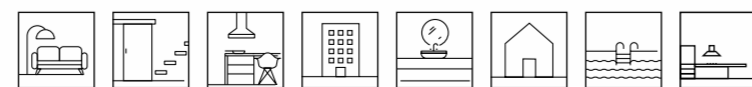

**Breccia Beige**

Finish : **Glossy**  
Random : **2**  
Body : **Color Body**  
Thickness: **15mm**



**800x2400mm**



**Dyna Crema**

Finish : **Glossy**  
Random : **2**  
Body : **Color Body**  
Thickness: **15mm**



Italian Technology | **FLEXIBLE BODY**





Vanity  
Onyx Brown

Floor & Wall  
Diamond Gold

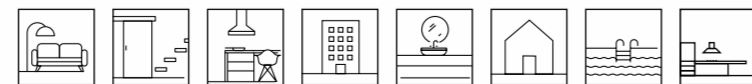

### Mascara

Finish : **Glossy**  
Random : **3**  
Body : **Color Body**  
Thickness: **15mm**



### Onyx Brown

Finish : **Glossy**  
Continue : **1**  
Body : **Color Body**  
Thickness: **15mm**



**800x2400mm**





Table Top  
**Korso Brown**

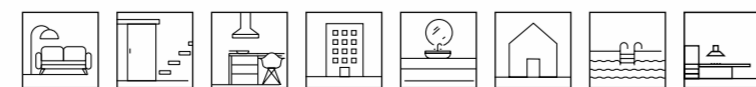

**Fusion Rose**

Finish : **Glossy**  
Body : **Color Body**  
Thickness: **15mm**



**800x2400mm**

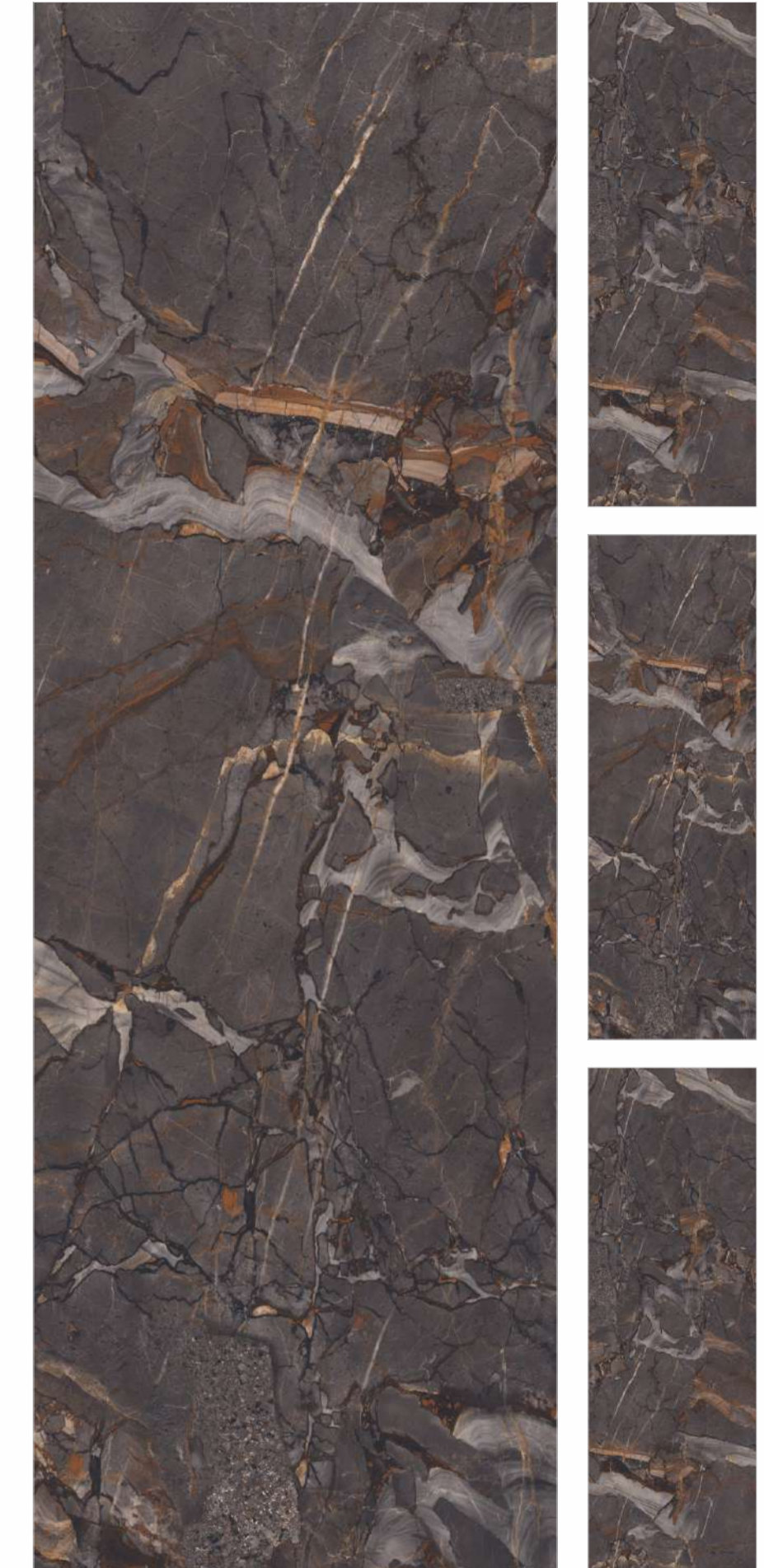

**Korso Brown**

Finish : **Glossy**  
Random : **2**  
Body : **Color Body**  
Thickness: **15mm**







Island Platform  
**Portofino Black**

Floor & Wall  
**Scropolato Nero**

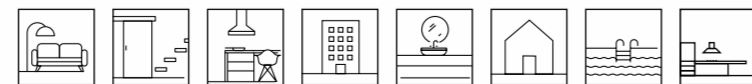

**Onyx Rosso**

Finish : **Glossy**  
Random: **2**  
Body : **Color Body**  
Thickness: **15mm**



**Portofino Black**

Finish : **Glossy**  
Continue : **2**  
Body : **Color Body**  
Thickness: **15mm**



**800x2400mm**

Italian Technology | **FLEXIBLE BODY**





Island Platform  
Louise Green

Floor  
Calacatta Gold

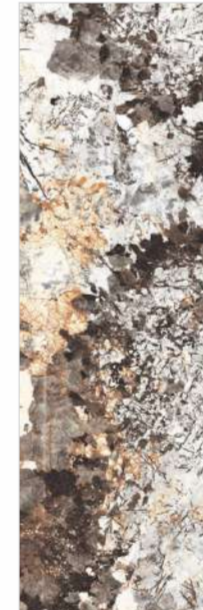
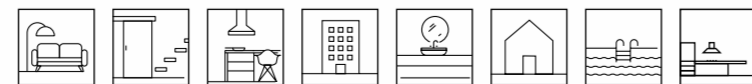

### Copenhagen

Finish : **Glossy**  
Random: **3**  
Body : **Color Body**  
Thickness: **15mm**



**800x2400mm**

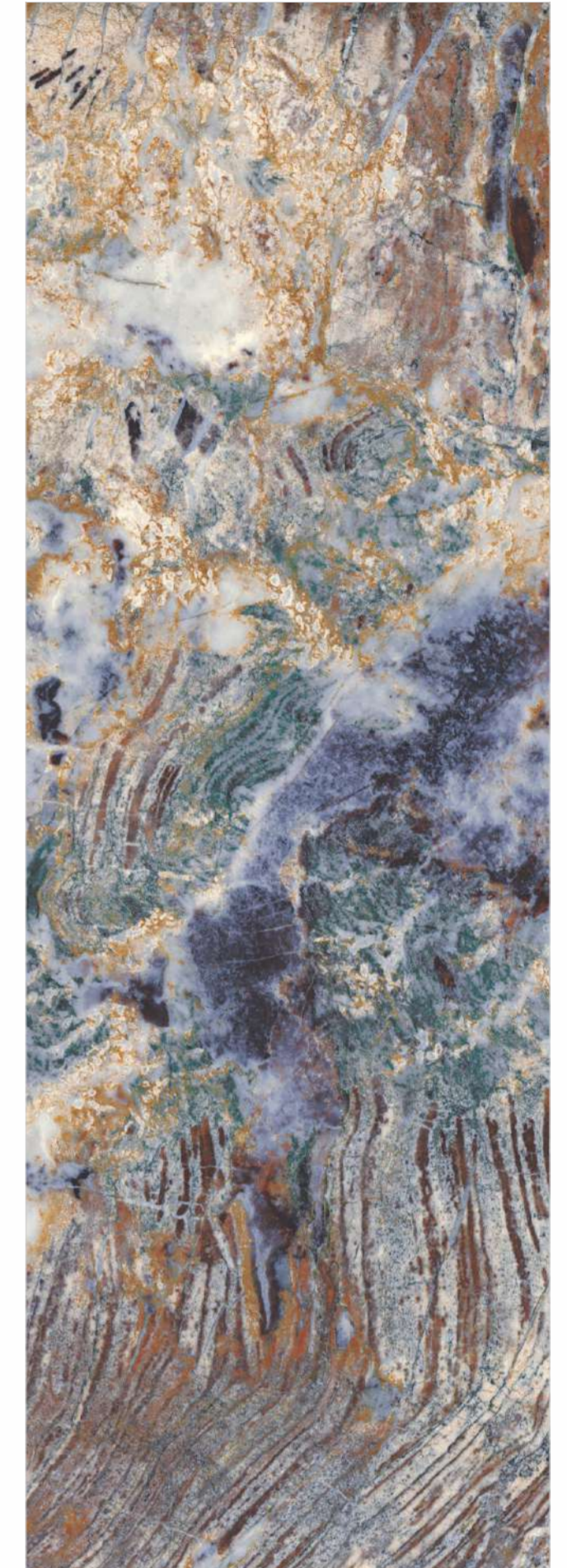

### Louise Green

Finish : **Glossy**  
Random: **2**  
Body : **Color Body**  
Thickness: **15mm**







Wall  
**Roma Black**

Floor  
**Red Spider**

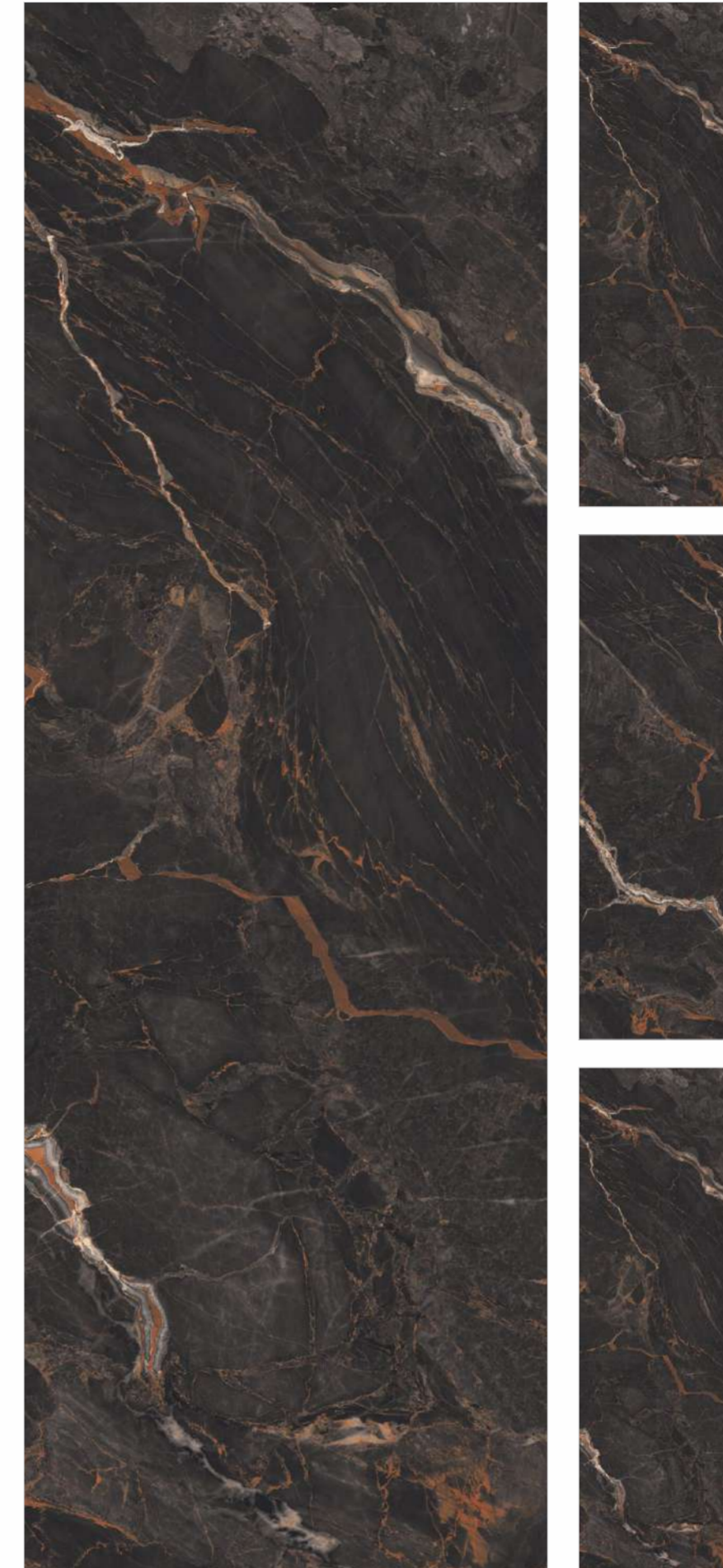
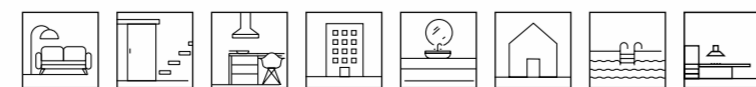

## Noir Desir

Finish : **Glossy**  
 Random: **2**  
 Body : **Color Body**  
 Thickness: **15mm**



**800x2400mm**

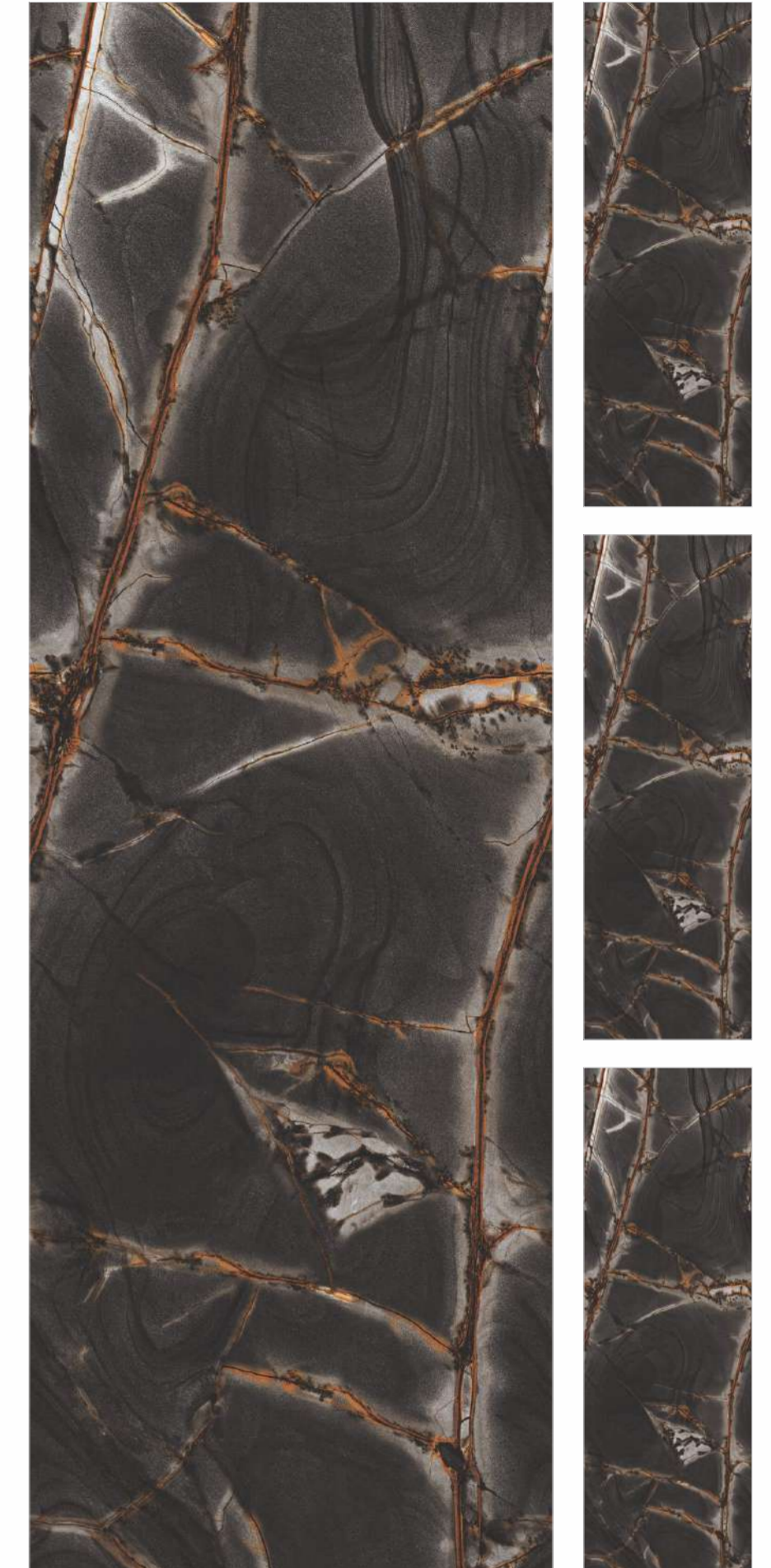

## Roma Black

Finish : **Glossy**  
 Continue : **1**  
 Body : **Color Body**  
 Thickness: **15mm**







Reception Counter  
**Portoro Black**

Wall  
**Portoro Black**

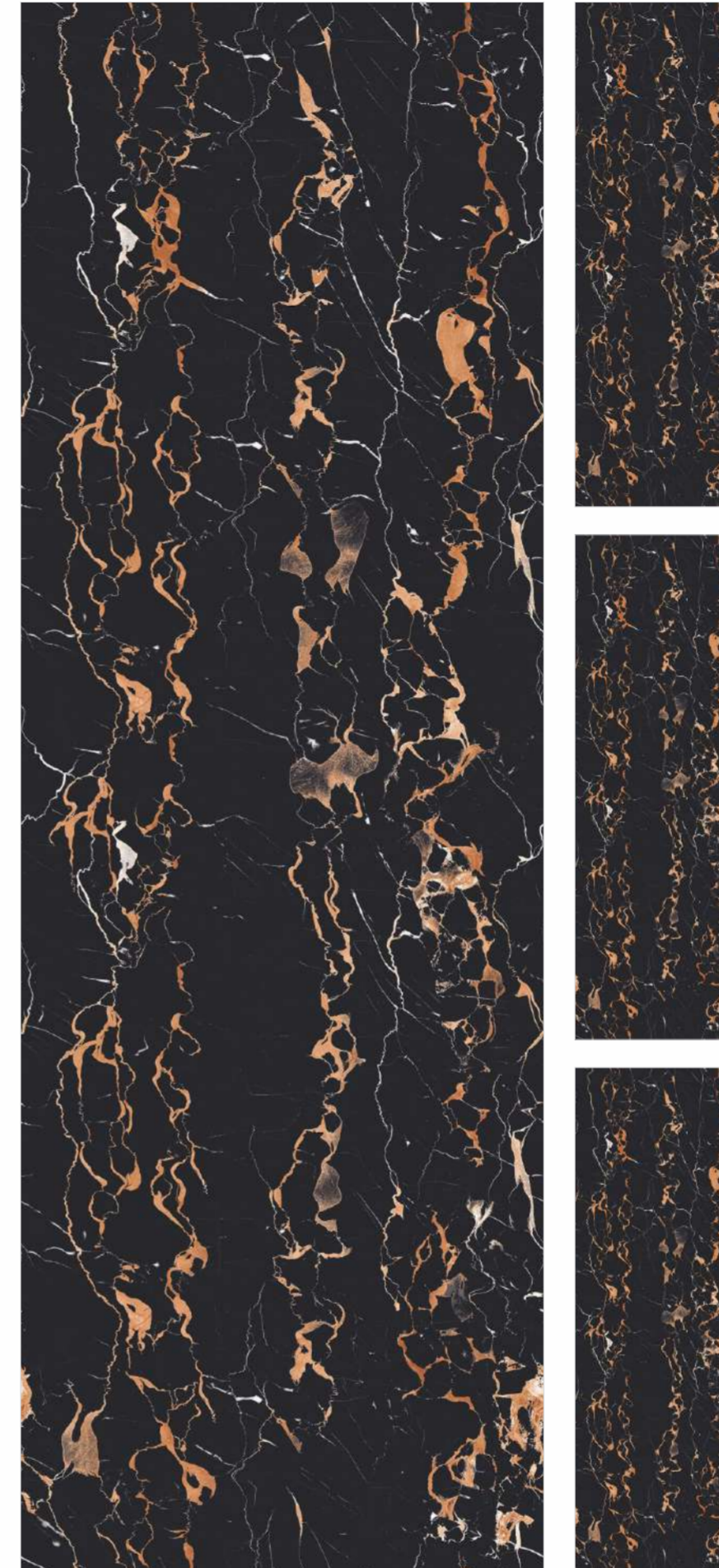
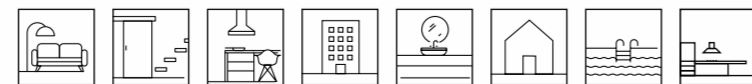

**Portoro Gold**

Finish : **Glossy**  
 Endless : **1**  
 Body : **Color Body**  
 Thickness: **15mm**



**800x2400mm**

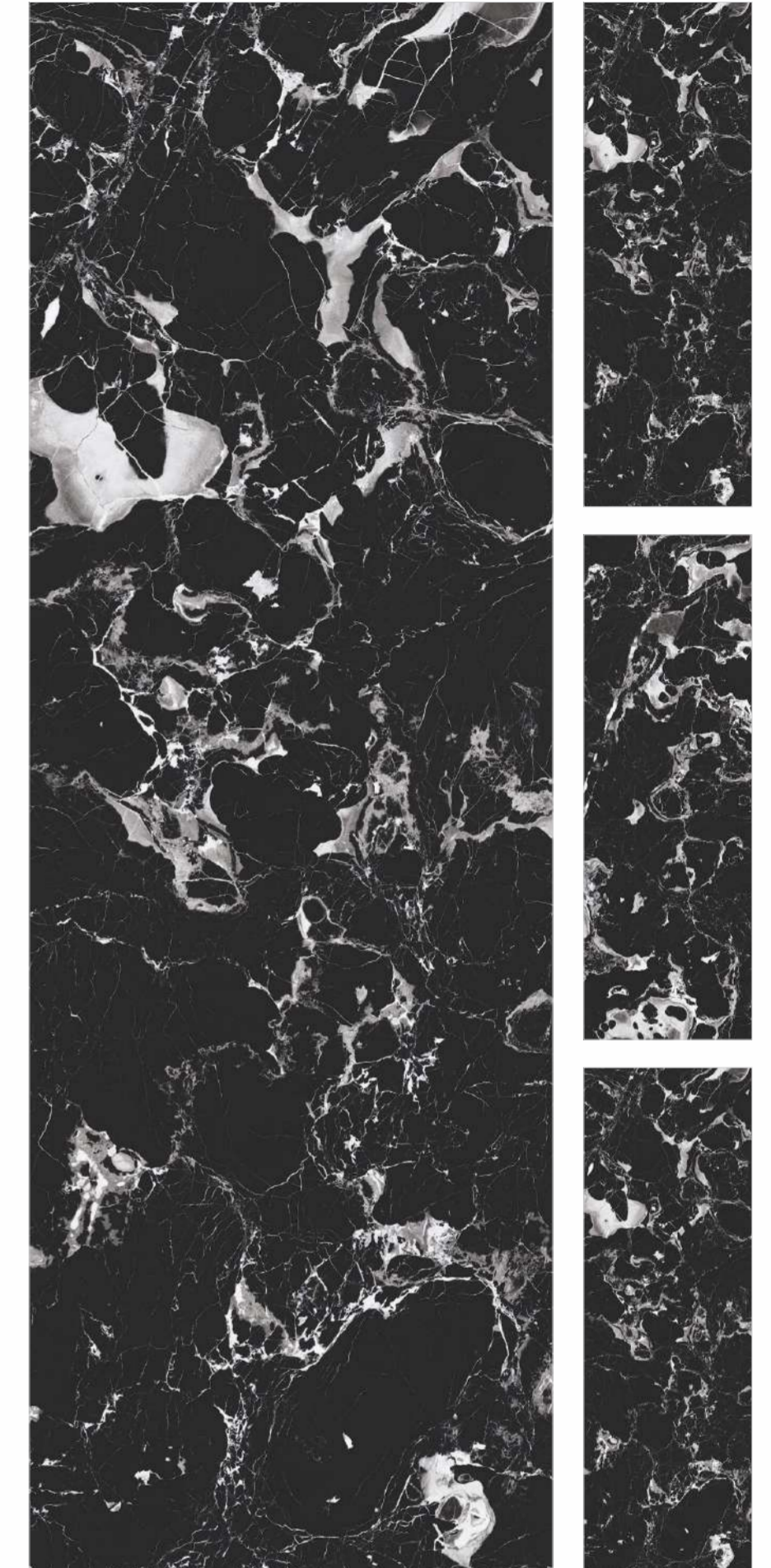

**Portoro Black**

Finish : **Glossy**  
 Random: **2**  
 Body : **Color Body**  
 Thickness: **15mm**







Wall  
**Infinito Grey**

Floor & Reception Counter  
**Mascara**

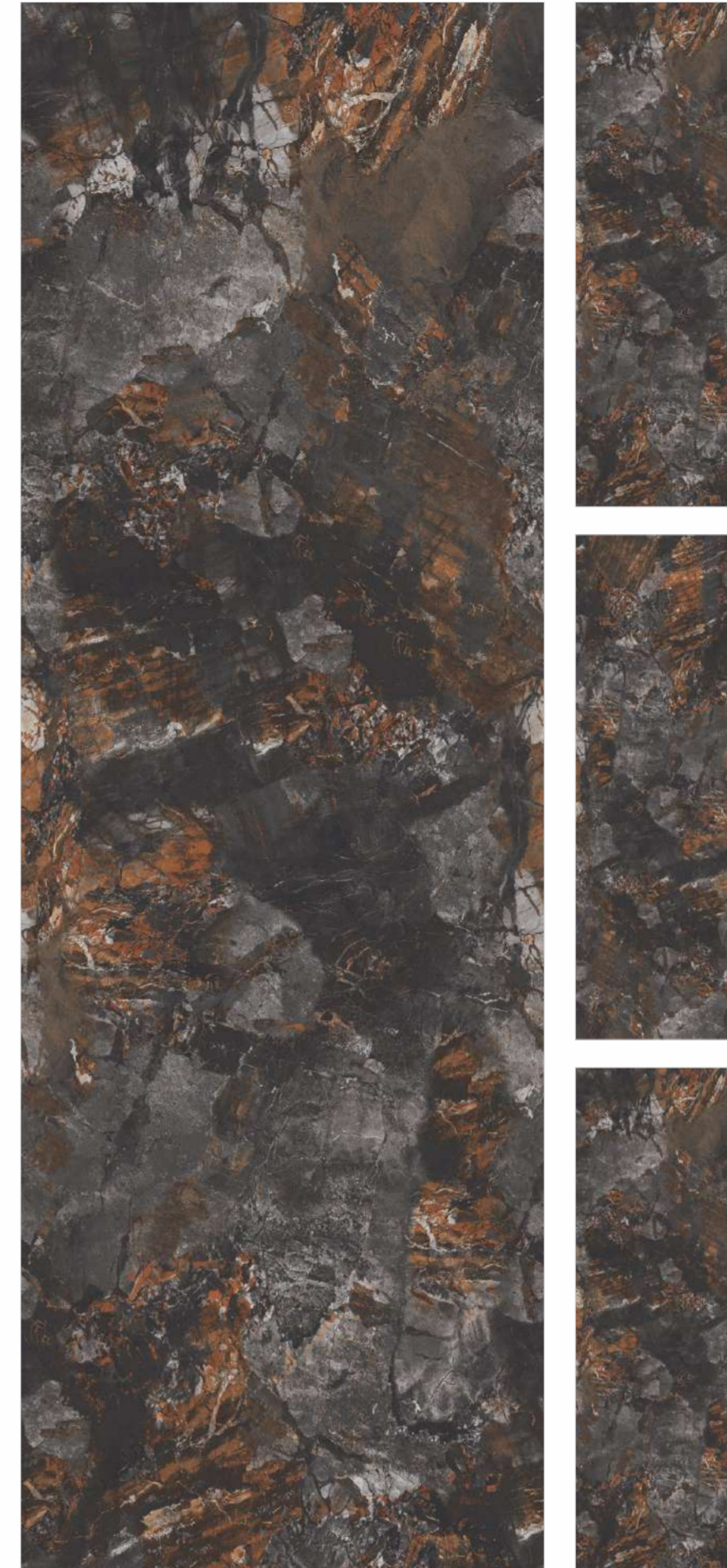
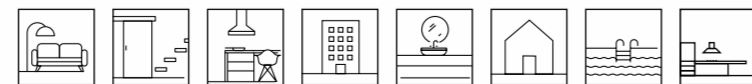

### Infinito Grey

Finish : **Glossy**  
Continue : **2**  
Body : **Color Body**  
Thickness: **15mm**



### Retrowood Black

Finish : **Glossy**  
Body : **Color Body**  
Thickness: **15mm**



**800x2400mm**

Italian Technology | **FLEXIBLE BODY**



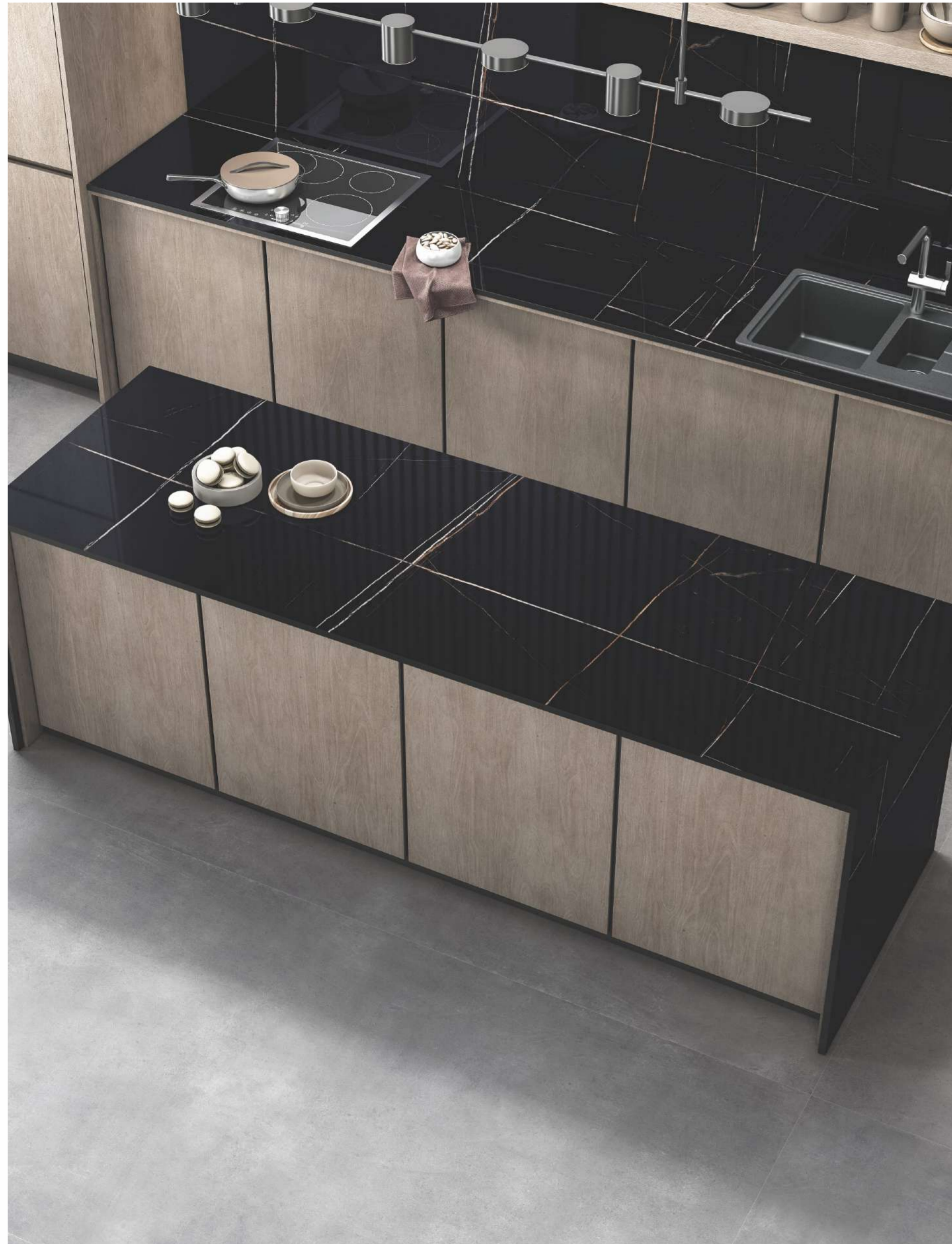

Island Platform  
**Saint Laurent**

Wall  
**Saint Laurent**

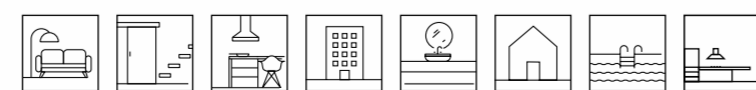

**Ambrato Nero**

Finish : **Glossy**  
Endless : **1**  
Body : **Color Body**  
Thickness: **15mm**



**800x2400mm**



**Saint Laurent**

Finish : **Glossy**  
Random : **2**  
Body : **Color Body**  
Thickness: **15mm**



Italian Technology |  **FLEXIBLE BODY**



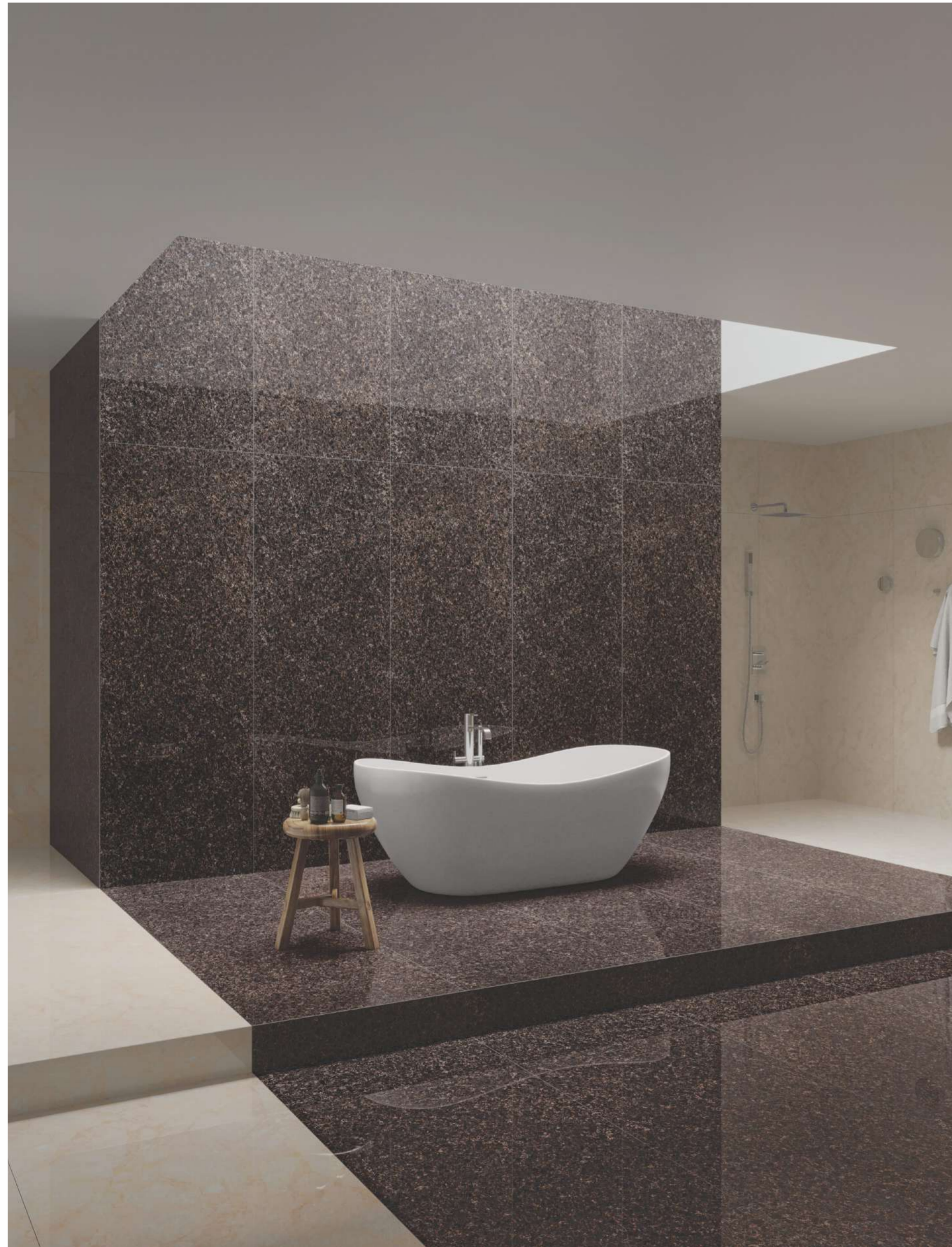

Floor & Wall  
**Coper Pearl & Victoria Beige**



**Fossil Brown**

Finish : **Glossy**  
Random : **2**  
Body : **Color Body**  
Thickness: **15mm**



**800x2400mm**



**Coper Pearl**

Finish : **Glossy**  
Body : **Color Body**  
Thickness: **15mm**



Italian Technology | **FLEXIBLE BODY**





Sitting Area  
**Roman Pearl**

Floor  
**Sunshine Crystal**



**Roman Pearl**

Finish : **Glossy**  
Body : **Color Body**  
Thickness: **15mm**



**800x2400mm**



**Choba**

Finish : **Glossy**  
Body : **Color Body**  
Thickness: **15mm**



Italian Technology | **FLEXIBLE BODY**





Floor & Wall  
**Volga Blue**

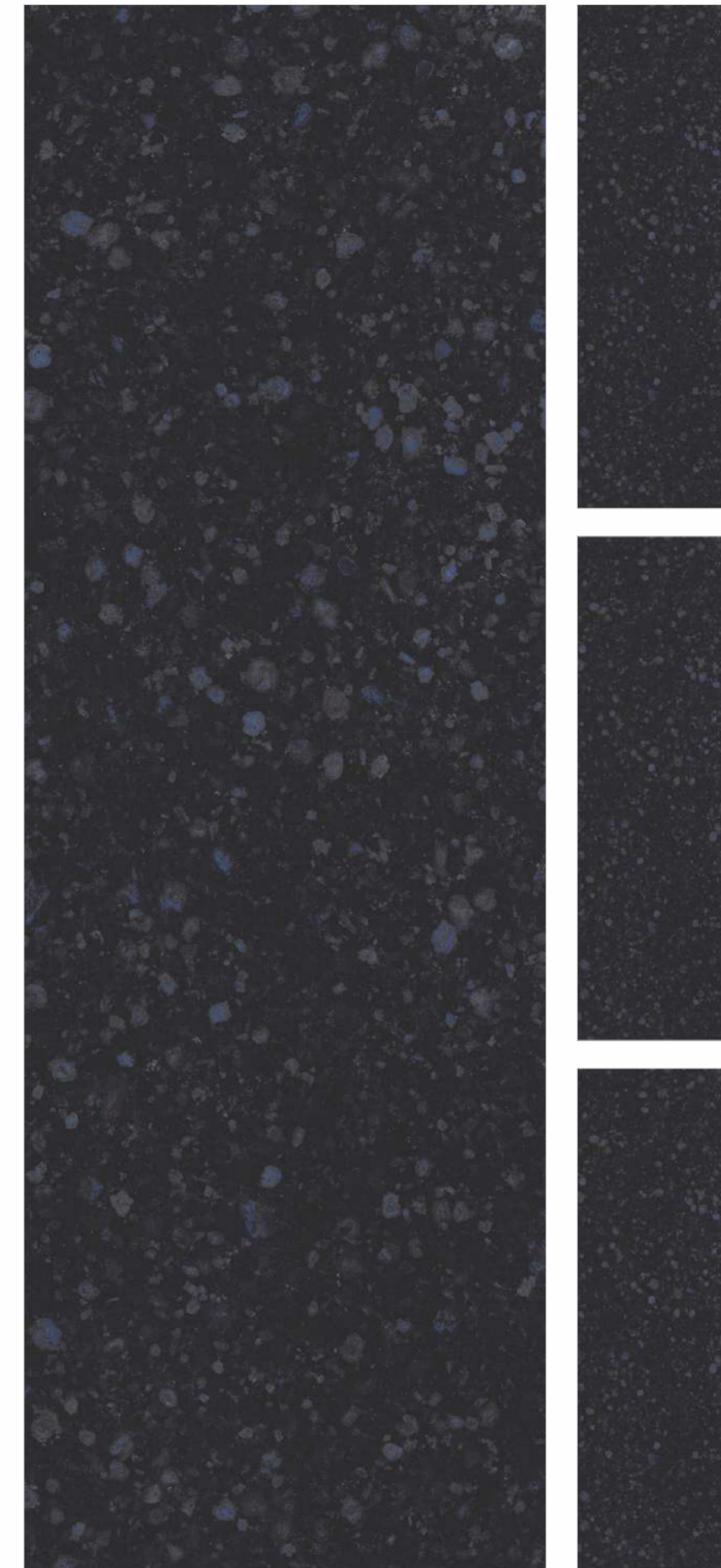

**Metalix Blue**

Finish : **Glossy**  
Body : **Color Body**  
Thickness: **15mm**

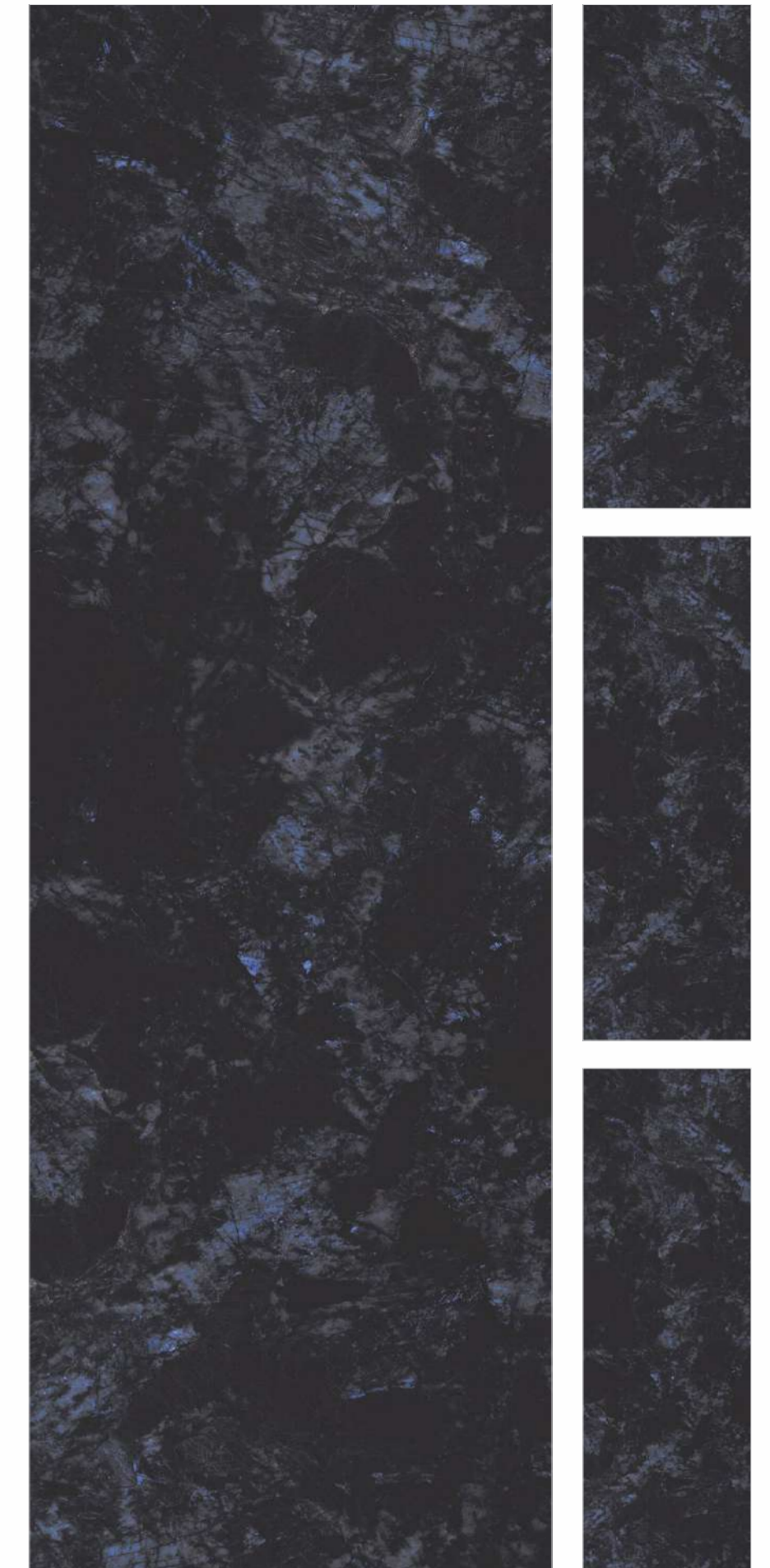

**Volga Blue**

Finish : **Glossy**  
Body : **Color Body**  
Thickness: **15mm**



**800x2400mm**

Italian Technology | **FLEXIBLE BODY**





Floor  
**Arizona Blue**

Wall & Floor  
**Arizona Blue & Diamond Gold**

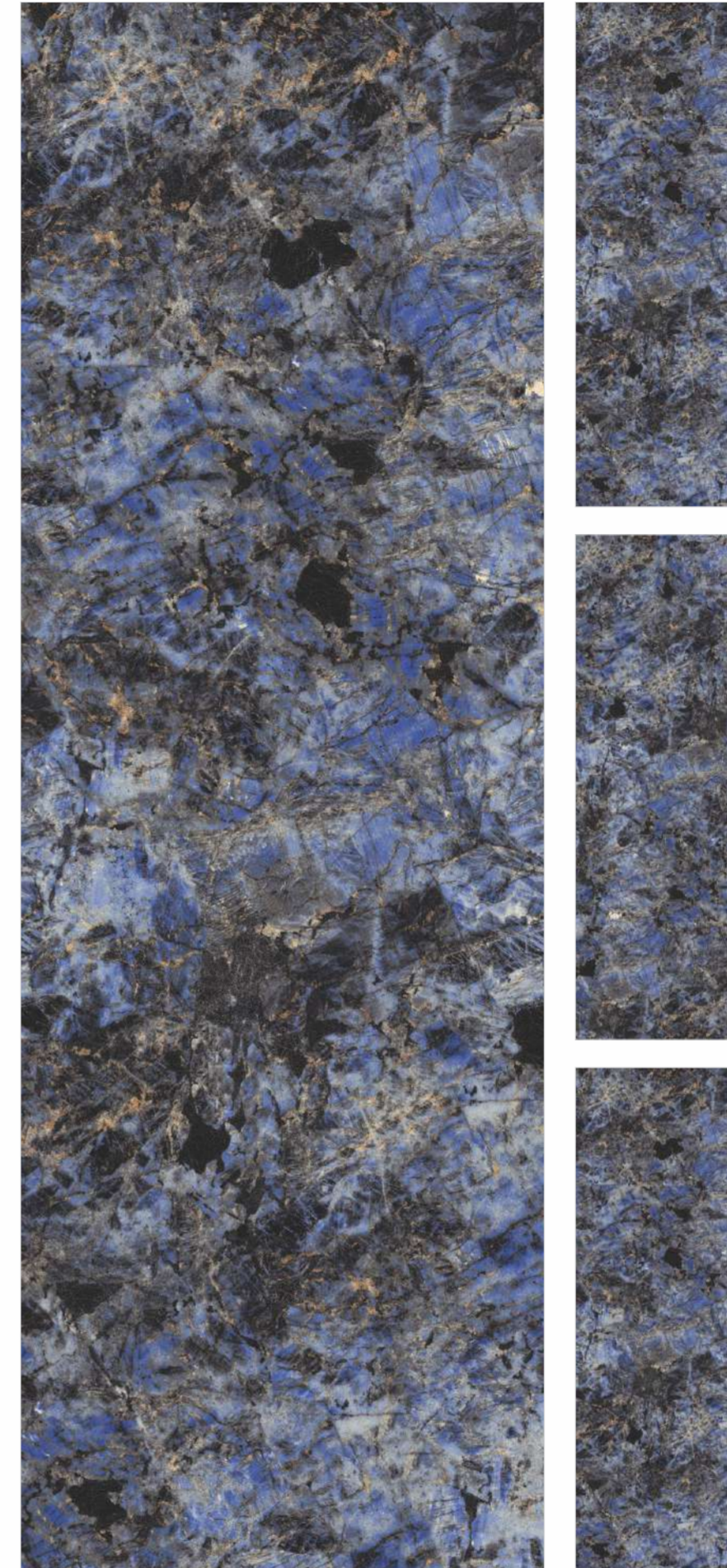
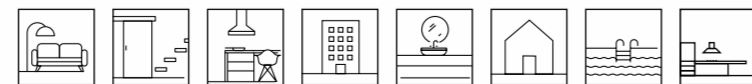

**Blue Agatha**

Finish : **Glossy**  
Random : **2**  
Body : **Color Body**  
Thickness: **15mm**

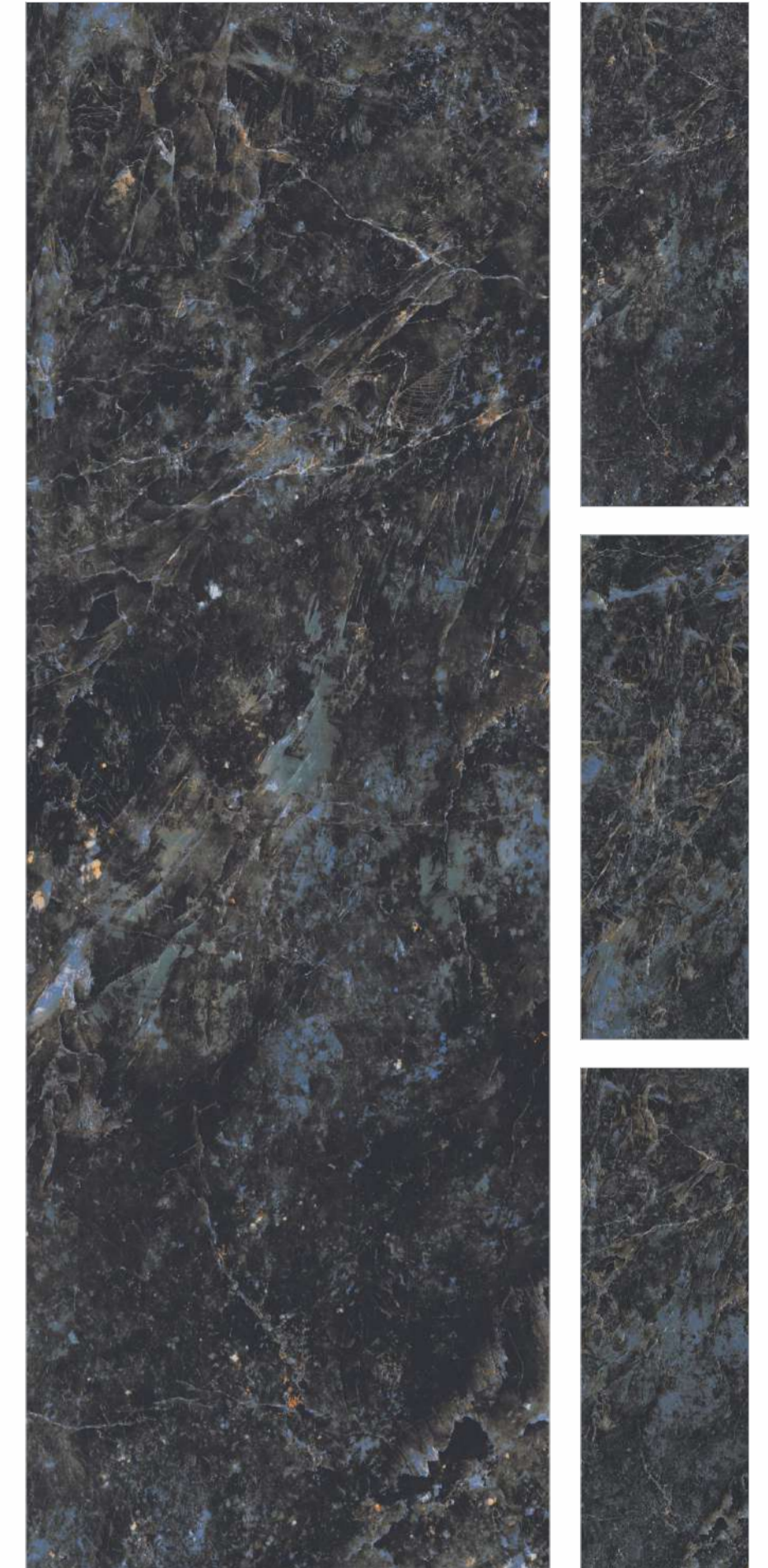

**Arizona Blue**

Finish : **Glossy**  
Random : **2**  
Body : **Color Body**  
Thickness: **15mm**



**800x2400mm**

Italian Technology | FLEXIBLE BODY





Stairs & Floor  
**Sunshine Crystal**

Wall  
**Sunshine Crystal Black**

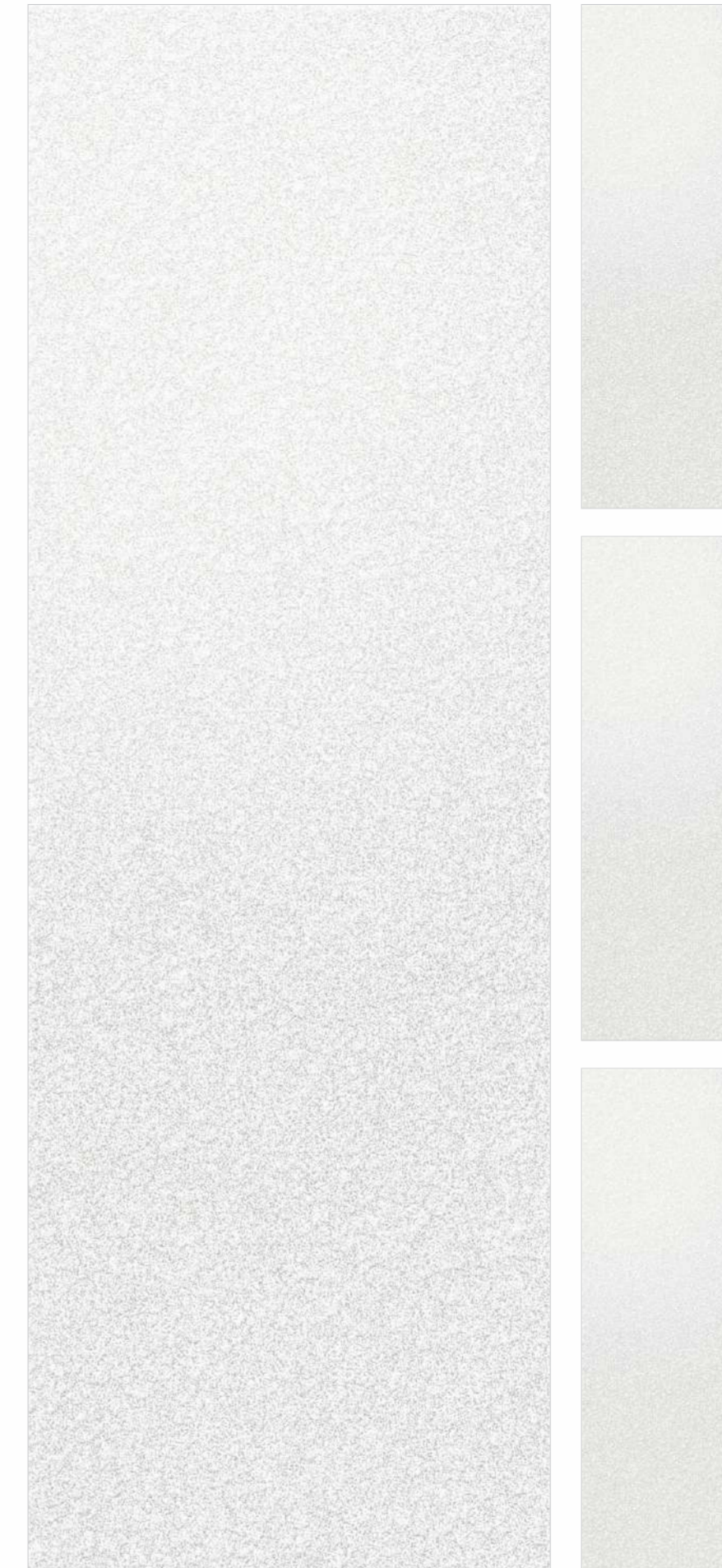

**Sunshine Crystal**

Finish : **Carving Matt**  
Body : **Color Body**  
Thickness: **15mm**



**800x2400mm**

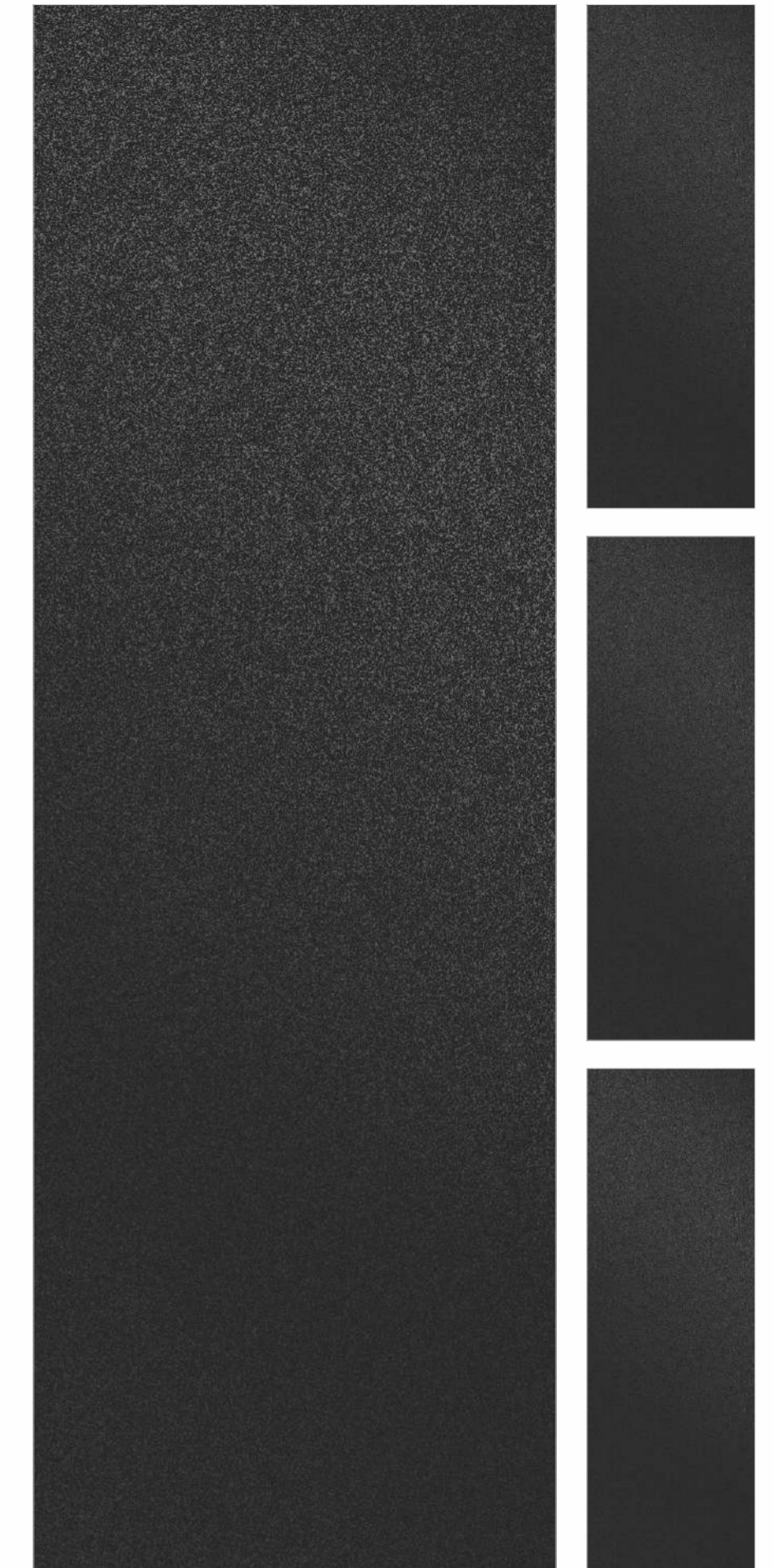

**Sunshine Crystal Black**

Finish : **Carving Matt**  
Body : **Color Body**  
Thickness: **15mm**



Italian Technology | FLEXIBLE BODY





Table Top  
**Sunshine Fancy**

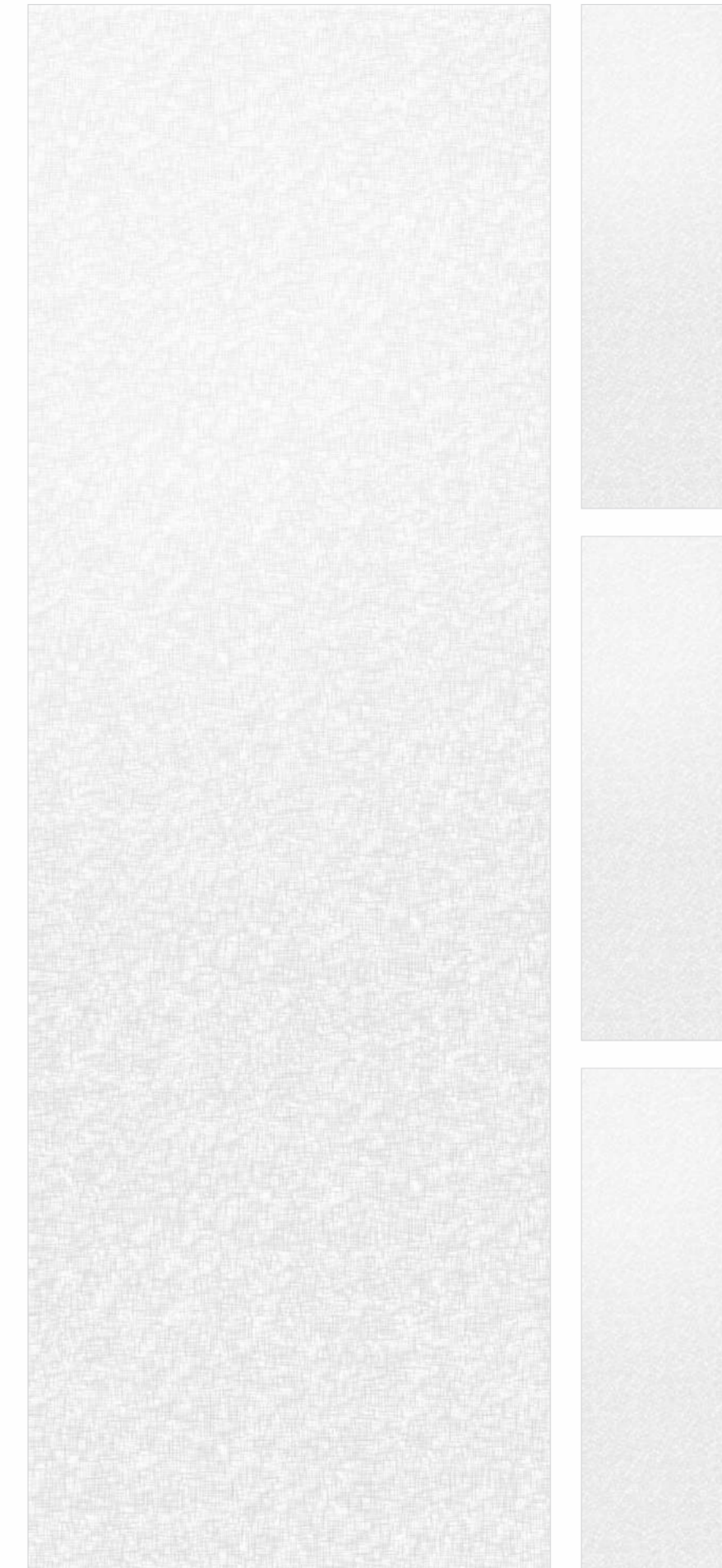
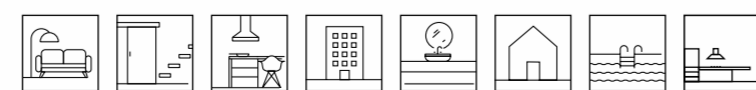

**Sunshine Fancy**

Finish : **Carving Matt**  
Body : **Color Body**  
Thickness: **15mm**



**800x2400mm**

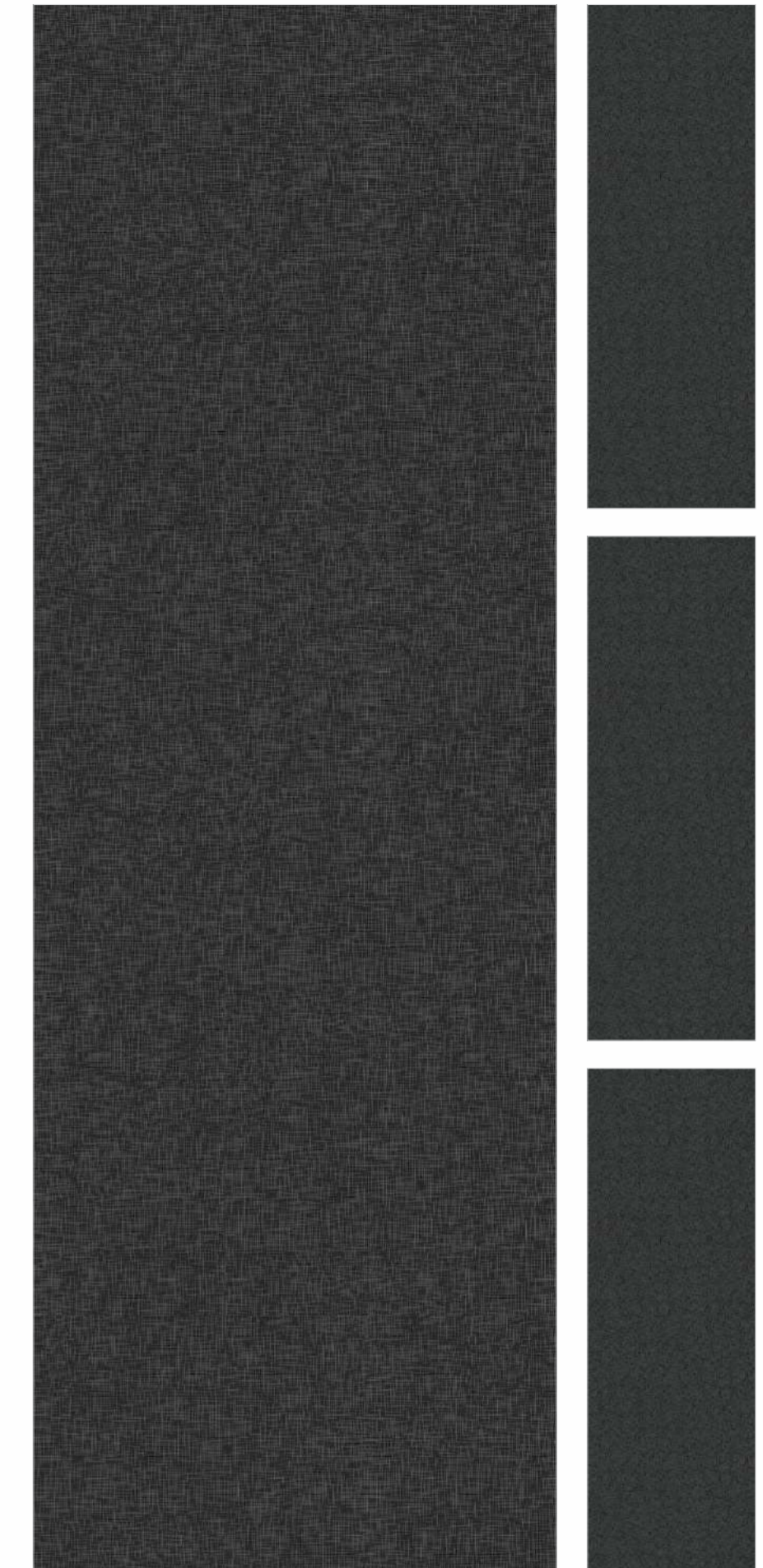

**Sunshine Fancy Black**

Finish : **Carving Matt**  
Body : **Color Body**  
Thickness: **15mm**



Italian Technology | **FLEXIBLE BODY**





## Orion White

Finish : **Carving Matt**

Body : **Color Body**

Thickness: **15mm**



Tabletop & Floor  
**Orion White**

Wall  
**Sunshine Fancy Black**



**800x2400mm**

Italian Technology

 **FLEXIBLE BODY**





Wash Basin  
**Orion Grey**

Floor & Wall  
**Orion Nero**

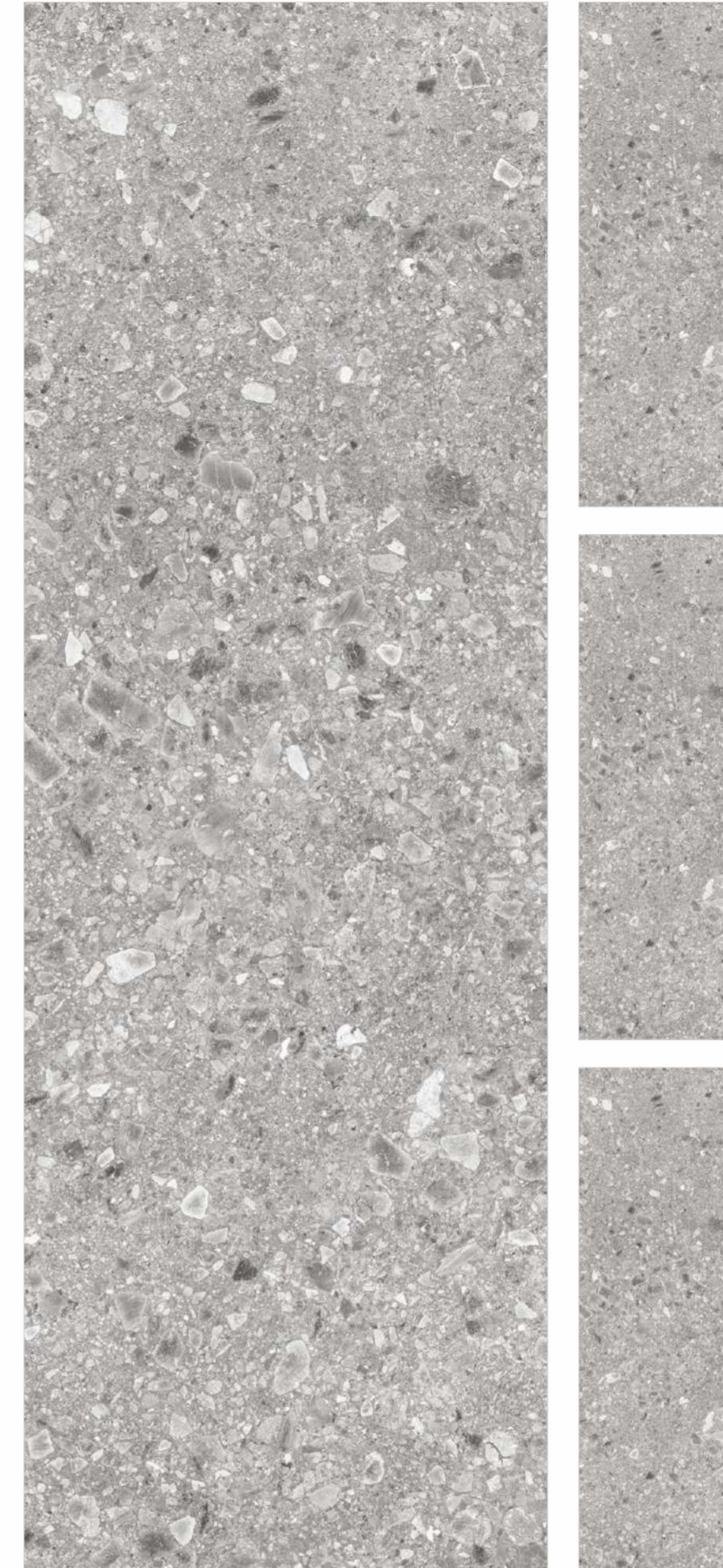
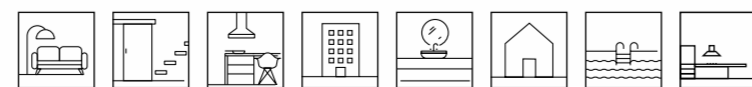

**Orion Grey**

Finish : **Carving Matt**  
Body : **Color Body**  
Thickness: **15mm**

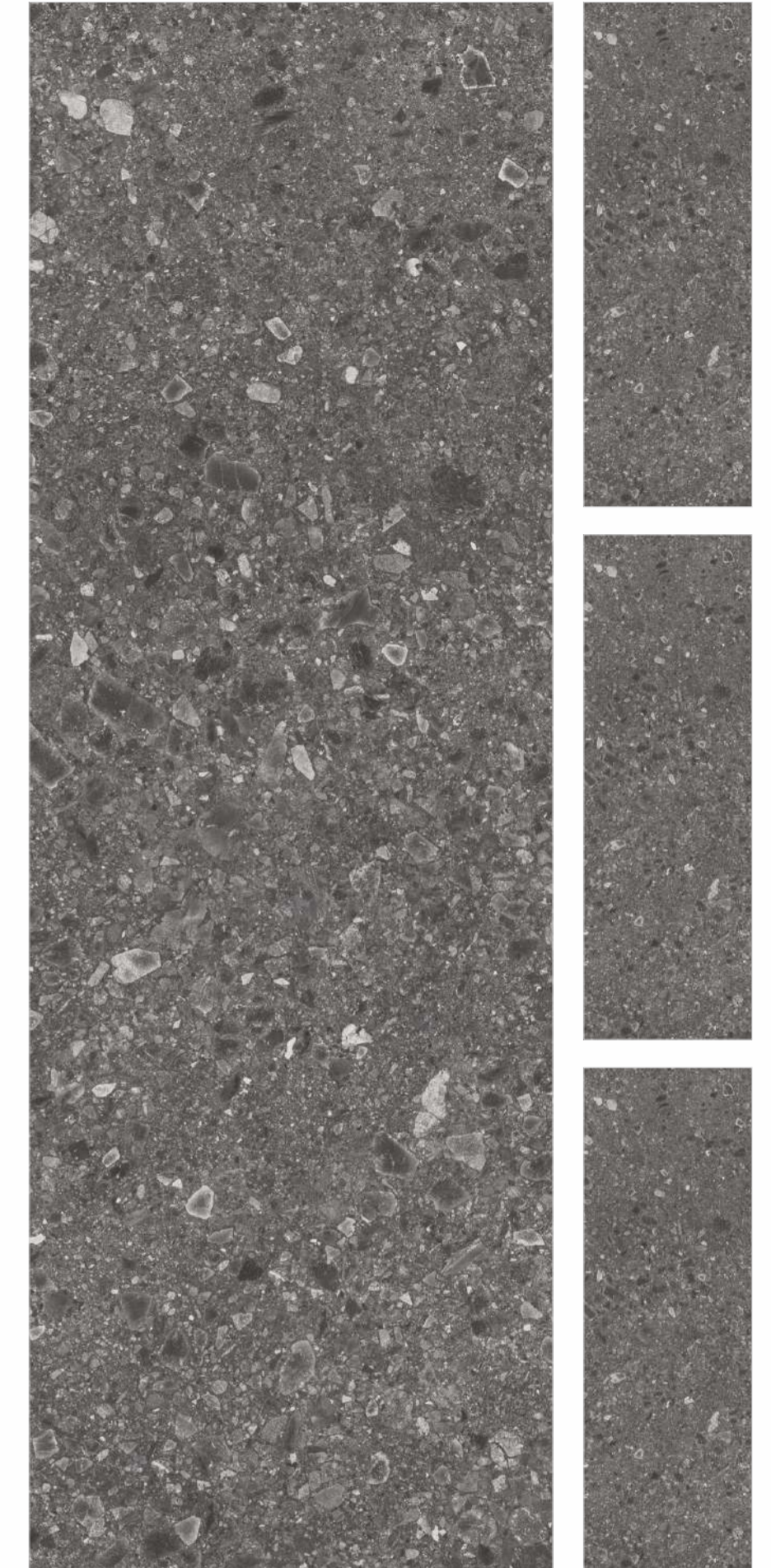

**Orion Nero**

Finish : **Carving Matt**  
Body : **Color Body**  
Thickness: **15mm**



**800x2400mm**

Italian Technology | FLEXIBLE BODY





Victoria Beige

Natural Marfil

Finish : **Carving Matt**  
Random : 2  
Body : **Color Body**  
Thickness: **15mm**



Finish : **Carving Matt**  
Random : 2  
Body : **Color Body**  
Thickness: **15mm**



Island Platform  
**Natural Marfil**

Floor  
**Natural Marfil**

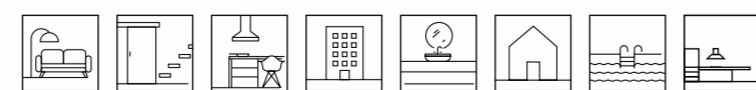

**800x2400mm**

Italian Technology |  **FLEXIBLE BODY**





Wall  
**Fontana Crema**

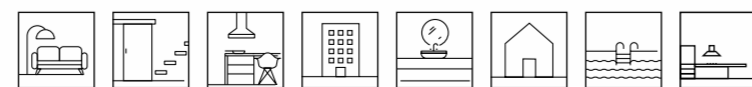

**Fontana Crema**

Finish : **Carving Matt**  
Endless : **1**  
Body : **Color Body**  
Thickness: **15mm**



**800x2400mm**



**Rosalia Gold**

Finish : **Carving Matt**  
Endless : **2**  
Body : **Color Body**  
Thickness: **15mm**





## MANUALLY TRANSPORTING SLAB

Only for 1/4" Slabs

### MOVING A SLAB

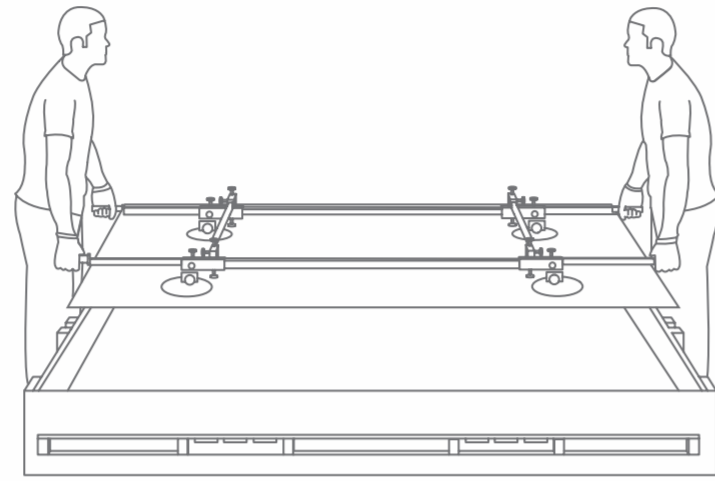
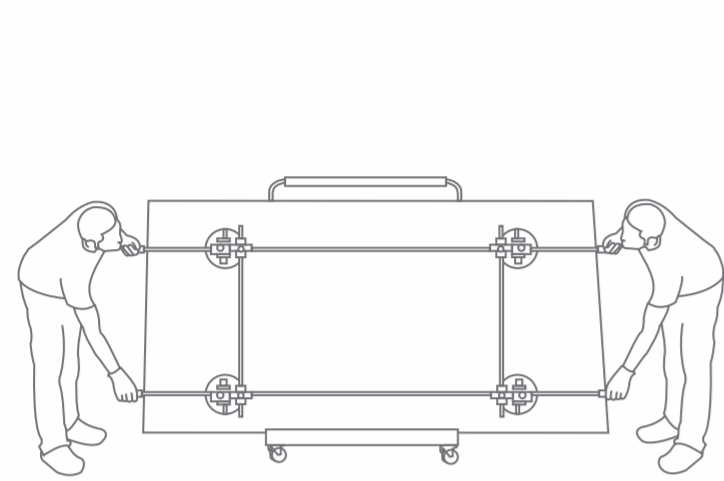

### RAISING A IMMEDIATE SLAB ONTO A BENCH

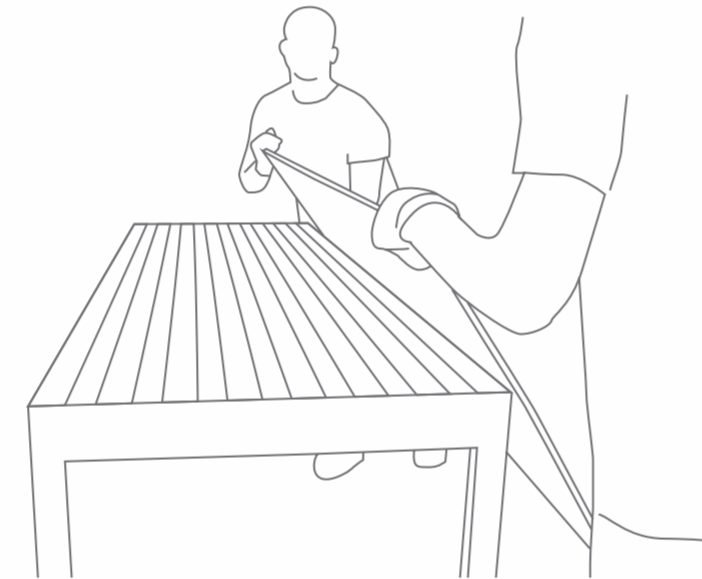
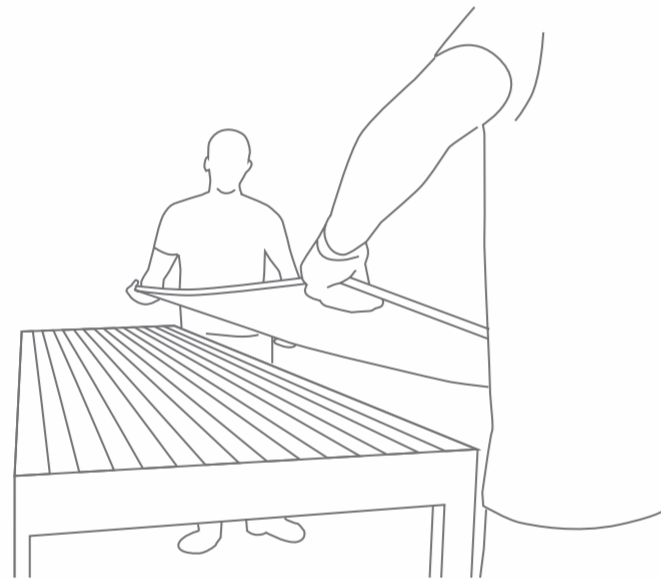

✗ INCORRECT

✓ CORRECT

### HANDLING IMMEDIATE SLAB FOR WALL

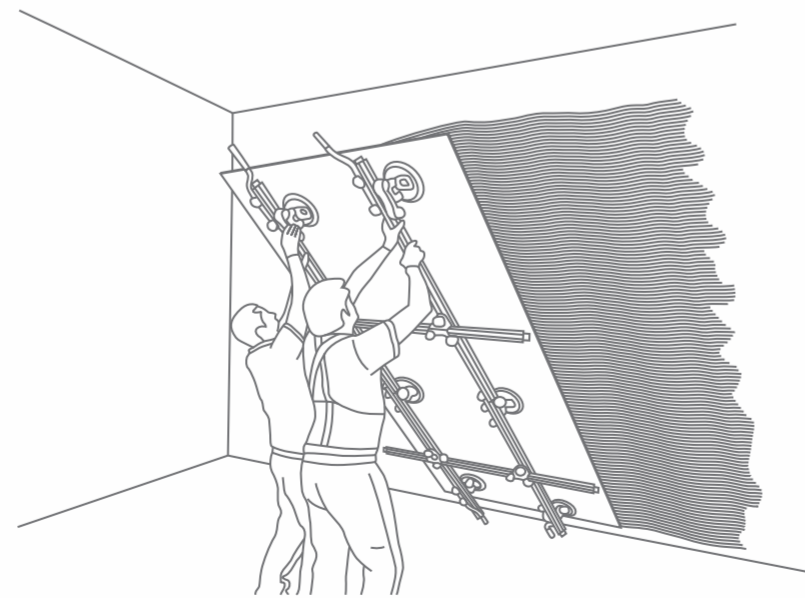
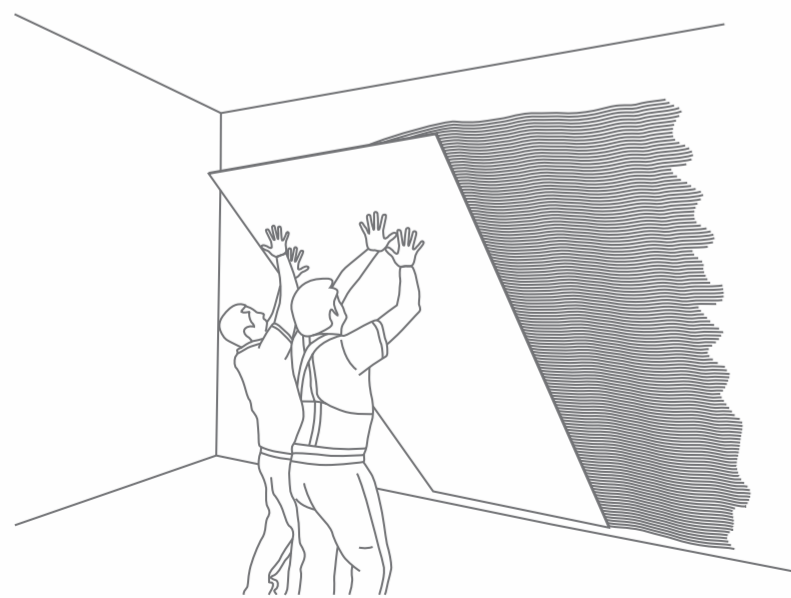

✗ INCORRECT

✓ CORRECT

## WORKING WITH THE VARIOUS VERSIONS OF SLAB

### CUTTING WITH DIAMOND DISCS

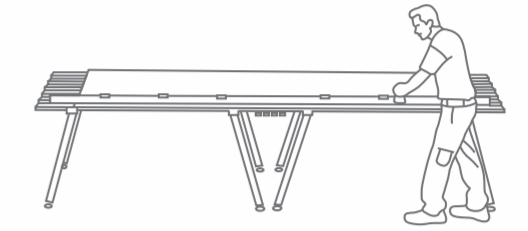

Our products can be cut using diamond discs fitted onto the hand-held electrical grinding machine. The speed of Disc rotation must be high (>10000 RPM) and should have a low feed rate (< 1 m/min). It may be required to cool the disc with water. Recommended discs are the thin types generally used for cutting porcelain stoneware. The surface should be kept on a FLAT base while cutting without any gap underneath.

### DRILLING

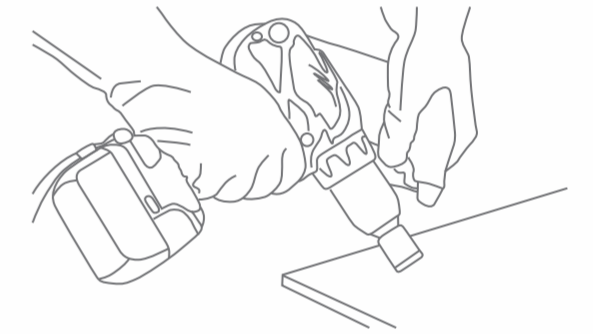
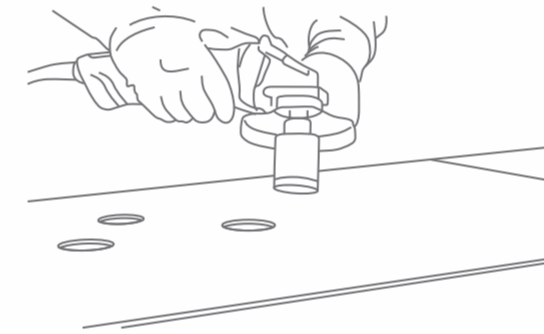

You can use cutting discs fitted to battery-operated screwdrivers or angle grinders, or electrical drills as an alternative.

### INTERNAL CUT/L-SHAPED CUT

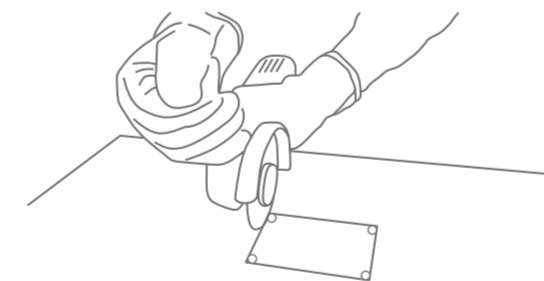

To get internal and L-shaped corners & to reduce the risk of breakage, cut 'o' at the vertex of the internal corners using bits with a radius of at least 5mm. Then cut with diamond discs, be cautious to stop moving the cutting tool forward. To drill and cut using diamond discs, and more follow the instructions provided below:

- When using these tools:
- Cool the point being drilled with water
  - Don't put too much pressure and bear in mind the resistance of the type of laminated stoneware you are working on
  - If you are using tungsten bits, start drilling at a low speed
  - If you are using drills or screwdrivers, do not select hammering mode

### EDGE-FINISHING

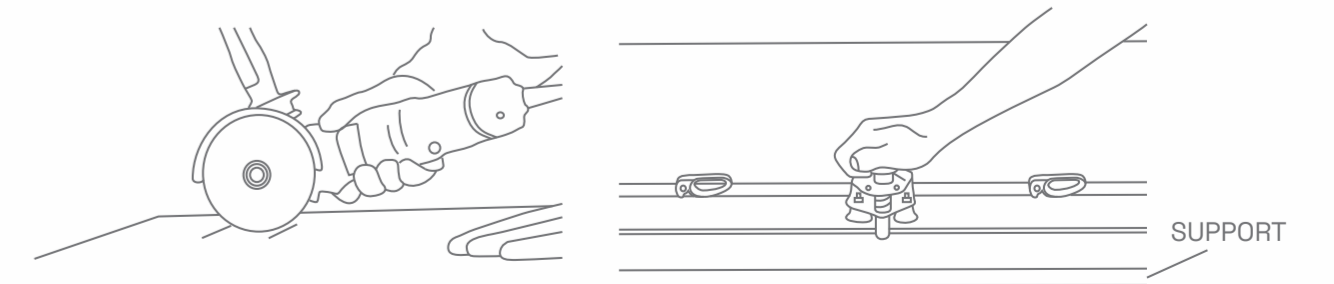

SUPPORT



## INSTRUCTIONS FOR MANUAL INSTALLATION

### SINGLE LAYER METHOD

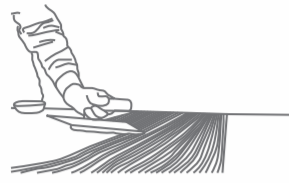

### DOUBLE-LAYER METHOD

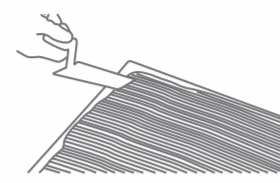

### COMPRESSING THE SLAB

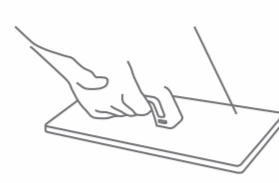

## IMPORTANT

All cutout corners must have a minimum diameter of 1/4". Never leave 90° angles. We recommend a radius of more than 1/4" when the kitchen design allows as it makes the countertop firmer.



✓ CORRECT



✗ INCORRECT



✗ INCORRECT



✗ INCORRECT

## CLEANING & MAINTENANCE

Our products are non porous (due to their high quality raw materials, stringent production parameters and state of the art technology), hence any dust or deposited waste cannot penetrate the surface.

For most cases only a damp cloth is sufficient for cleaning.

Regular cleaning highlights the aesthetic features of the surface and gives it exceptional shine.

For highly aggressive cleaning caused by some common food and substances follow the table below.

| TYPE OF STAIN | CHEMICAL PRODUCT   | EXAMPLE                                    |
|---------------|--------------------|--|
| Grease        | Alkaline - Solvent | Detergent                                  |
| Oil           | Solvent            | Ammonia, Backing Soda                      |
| Ink           | Oxidant - Solvent  | Alcohol, Liquid Bleach, Nail Paint Remover |
| Rust          | Acid               | Hydrochloric Acid, Vinegar, Red Harpic     |
| Lime          | Acid               | Descaling Reagent, Hydrochloric Acid       |
| Cement        | Acid               | Hydrochloric Acid                          |
| Wine          | Alkaline           | Ammonia, Liquid Bleach                     |
| Coffee        | Alkaline - Solvent | Ammonia, Liquid Bleach                     |
| Rubber        | Solvent            | Alcohol, Thinner                           |
| Plaster       | Acid               | Hydrochloric Acid                          |
| Candle Wax    | Solvent            | Alcohol, Thinner                           |
| Iodine        | Oxidant            | Liquid Bleach                              |
| Blood         | Oxidant            | Liquid Bleach                              |
| Ice Cream     | Alkaline           | Liquid Bleach                              |

Note: It is recommended that any kind of stain needs to be cleaned immediately, as soon as possible.

## TECHNICAL SPECIFICATIONS

| CHARACTERISTICS                      | STANDARD AS PER ISO-13006/2018 En14411 gr.bla | MOTTO VALUE               | TEST METHOD  |
|--------------------------------------|---|---------------------------|--------------|
| <b>Regulatory Properties</b>         |   |                           |              |
| Deviation in Length & Width          | ± 0.5%  | ± 0.2%                    | ISO 10545-2  |
| Deviation in Thickness               | ± 5%  | ± 5%                      | ISO 10545-2  |
| Straightness of Sides                | ± 0.5%  | ± 0.2%                    | ISO 10545-2  |
| Rectangularity                       | ± 0.5%  | ± 0.2%                    | ISO 10545-2  |
| Surface Flatness                     | ± 0.5%  | ± 0.3%                    | ISO 10545-2  |
| Colour Difference                    | 6E<1.00                                       | 6E<0.30                   | ISO 10545-16 |
| Glossiness                           | As per Mfg.                                   | As Per Mfg.               | Gloss Meter  |
| <b>Regulatory Properties</b>         |   |                           |              |
| Water Absorption                     | ≤ 0.5 %                                       | ≤ 0.3 %                   | ISO 10545-3  |
| Apparent Density                     | As Per Mfg.                                   | >2.20 g/cc                | ISO 10545-3  |
| <b>Massive Mechanical Properties</b> |   |                           |              |
| Modulus of Rupture                   | Min.35N/mm <sup>2</sup>                       | Min.40N/mm <sup>2</sup>   | ISO 10545-4  |
| Breaking Strength                    | Min. 1300 N                                   | Min. 5000 N               | ISO 10545-4  |
| Impact Resistance                    | As per Mfg.                                   | Min. 0.55                 | ISO 10545-4  |
| <b>Surface Mechanical Properties</b> |   |                           |              |
| Surface Abrasion Resistance          | As per Mfg.                                   | Min. class 3              | ISO 10545-7  |
| Mohs Hardness                        | As per Mfg.                                   | Min. class 4              | BS EN 15771  |
| <b>Massive Mechanical Properties</b> |   |                           |              |
| Frost Resistance                     | As Per Mfg.                                   | Frost Proof               | ISO 10545-12 |
| Thermal Shock Resistance             | Min. 10 Cycle                                 | Min. 10 Cycle             | ISO 10545-9  |
| Moisture Expansion                   | Max. 0.6mm/m                                  | Max. 0.02mm/m             | ISO 10545-10 |
| Thermal Expansion                    | Max. 9.0 x 10 <sup>-6</sup>                   | Max. 6.0x10 <sup>-6</sup> | ISO 10545-8  |
| <b>Chemical Properties</b>           |   |                           |              |
| Chemical Resistance                  | As Per Mfg.                                   | No Damage                 | ISO 10545-13 |
| Stain Resistance                     | Resistant                                     | Resistant                 | ISO 10545-14 |
| <b>Safety Properties</b>             |   |                           |              |
| Slip Resistance                      | As per Mfg.                                   | N. A.                     | DIN 51130    |
| Fire Resistance                      | As per Mfg.                                   | Fire Proof                | N. A.        |

## PACKING DETAILS

| Dimension (mm) | No. of Pcs/Box | Square Feet  | Weight (Approx) |
|----------------|----------------|--------------|-----------------|
| 800x2400mm     | 1 Pcs.         | 20.67 Sq. ft | 68 kg.          |
| 800x3000mm     | 1 Pcs.         | 25.83 Sq. ft | 83 kg.          |



**ERIC**<sup>®</sup>  
REDEFINED BEAUTY